

Miele

Operating instructions

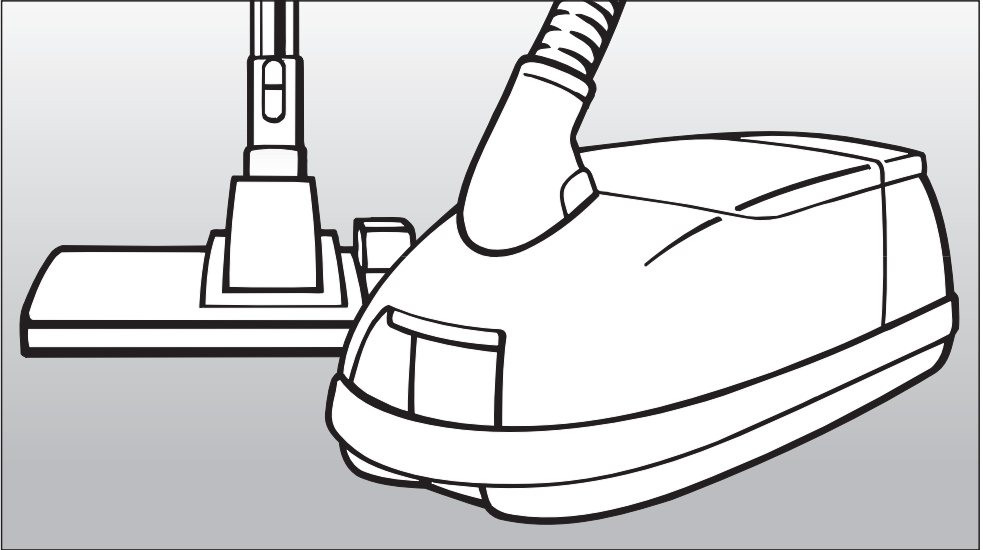

Vacuum cleaner

S 558

S 658

To prevent accidents
and machine damage,
read these instructions
before installation and use.

HS05
HS06



M.-Nr. 05 638 551

IMPORTANT SAFETY INSTRUCTIONS	4
INSTRUCTIONS IMPORTANTES SUR LA SÉCURITÉ	9
Guide to the vacuum cleaner	14
Before using for the first time	16
Included accessories	20
Using the included accessories	22
Crevice nozzle	22
Crevice nozzle extension	22
Dusting brush	23
Upholstery nozzle	23
Operation	24
Unwinding and rewinding the power cord	24
Auto-reverse	24
Turning the vacuum on and off	25
Adjusting the suction	26
Turning the Electrobrush on and off	27
Blower connection socket	28
Setting down, transport and storage	29
Park-System	29
Maintenance and care	30
Purchasing new dustbags and filters	30
When to change the dustbag	31
Replacing the dustbag	32
Replacing the exhaust filter	33
Replacing the "ACTIVE HEPA" filter	34
Replacing one type of filter with another	35
When to change the dust compartment filter (motor protection)	36
Replacing the dust compartment filter	36
Cleaning and care	37
Problem solving guide	38
Technical Service	39
Optional accessories	40
Electrical connection	45
Caring for the environment	46

IMPORTANT SAFETY INSTRUCTIONS

When using an electrical appliance, basic precautions should always be followed, including the following:

READ ALL INSTRUCTIONS BEFORE USING THIS APPLIANCE

The manufacturer cannot be held responsible for any damage caused through non-observance of these Important Safety Instructions.

WARNING-

To reduce the risk of fire, electric shock or injury:

Before using

■ Check the voltage rating of the vacuum cleaner before connecting the power cord to an electrical outlet. Your power source should correspond with the voltage rating plate located on the underside of the vacuum. Use only household AC outlets. Never use DC power sources. If you are not sure of your home's voltage supply, consult a qualified electrician. Connecting the vacuum cleaner to a higher voltage than indicated in these instructions may result in damage to the vacuum cleaner or injury.

■ To reduce the the risk of electric shock, this appliance has a polarized plug (one blade is wider than the other.) This plug will fit in a polarized outlet only one way. If the plug does not fit fully in the outlet, reverse the plug. If it still does not fit, contact a qualified electrician to install the proper outlet. Do not change the plug in any way.

■ A damaged vacuum cleaner can be dangerous. Check the packaging, the vacuum cleaner and accessories for any signs of damage. Do not use a damaged appliance.

■ Do not use with a damaged cord or plug. If the appliance is not working as it should, has been dropped, damaged, left outdoors or immersed in water, bring it to a service center.

IMPORTANT SAFETY INSTRUCTIONS

Use

- Do not use on people or on animals.
- Do not use outdoors or on wet surfaces. Only **dry** surfaces should be vacuumed.
- Use only as described in this manual. Use only Miele recommended accessories.
- The manufacturer cannot be held responsible for damage caused by non-compliance with these Important Safety Instructions. This appliance is intended strictly for household use only.
- Under absolutely no circumstances should this vacuum cleaner be used to arrest, retain and/or contain the anthrax virus or any other hazardous chemical or biological particles. While Miele's HEPA filter is certified to retain micro-particles, once any biohazardous material is introduced into the vacuum, the entire vacuum cleaner unit, floor tools, wand, and hose become contaminated, rendering them all a biohazard. Thereafter, this contaminated appliance and the entire environment would require the attention of the Center for Disease Control and Prevention (CDC) to employ biohazard cleanup procedures.

Child safety

- Do not allow the vacuum cleaner to be used as a toy. Close attention is necessary when used by or near children.

Daily use

- Do not pull or carry by the cord, use the cord as a handle, close a door on the cord, or pull the cord around sharp edges or corners. Do not run the appliance over the cord. Keep the cord away from heated surfaces.
- The suction hose and the telescopic wand contain electrical wires. Do not use the vacuum cleaner if these parts are damaged, cut or punctured. Danger of electric shock!
- Do not unplug by pulling on the cord. To unplug, grasp the plug, not the cord.
- Do not handle the plug or vacuum with wet hands.
- Keep hair, loose clothing, fingers and all parts of the body away from openings and moving parts.
- Turn off all controls before unplugging.
- Use extra care when cleaning on stairs.

IMPORTANT SAFETY INSTRUCTIONS

Do not use to pick up flammable or combustible liquids, such as gasoline, or use in areas where they may be present.

Do not use the vacuum cleaner to pick up liquids, as this could impair the electrical safety of the vacuum cleaner. This applies to freshly shampooed carpets. Wait until they dry.

Do not pick up anything that is burning or smoking, such as cigarettes, matches, or hot ashes.

Do not vacuum up items which are heavy, hard or have sharp edges. They could cause a blockage and damage the appliance.

Do not vacuum toner dust. Toner, such as that used in printers and photocopiers can conduct electricity.

Always turn off the vacuum before connecting or disconnecting the Electrobrush, Turbobrush or accessories.

Do not use without dustbag and/or filters in place.

Do not turn on or attempt to operate the vacuum cleaner unless a dustbag, dust compartment filter and exhaust filter are in place. Use only genuine Miele double-layer dustbags and filters (see "Maintenance" for instructions on how to insert the dustbag and filters.) If a dustbag has not been inserted, the dust compartment cover will not close. Do not use force!

To aid the vacuum in dissipating heat during extended operation (longer than 1 hour), the Auto-Reverse feature should be turned off and the power cord should be unwound from the cable reel at least two thirds of the way.

A temperature limiter automatically switches off the vacuum cleaner if it gets too hot, see "Problem solving guide".

On the underside of the vacuum hand piece is a metal insert designed to absorb electrostatic charge. Please make certain that your hand remains around this metal insert.

IMPORTANT SAFETY INSTRUCTIONS

Accessory use

■ The Miele Electrobrush is a motor driven accessory for use only with Miele vacuum cleaners. It must not be used with vacuum cleaners produced by other manufacturers.

■ When vacuuming with the Miele Electrobrush or Turbobrush, do not touch the rotating brush.

■ When using the vacuum with an Electrobrush and current-carrying hose: The hose contains electrical wires. Do not use when damaged, cut, or punctured. Avoid picking up sharp objects.

■ The socket on the vacuum cleaner must only be used for the Miele Electrobrush specified for use with this appliance.

■ Use only attachments specified by Miele. Do not use the blower to operate paint sprayers or similar devices that emit volatile or toxic vapors.

■ Monitor the dustbag change indicator and inspect all filters regularly. To ensure efficient suction, clean or replace them when necessary according to the operating instructions. To guarantee safety, only use genuine Miele dustbags, filters and accessories.

■ Miele vacuum cleaner bags are disposable and intended to be used only once. Do not attempt to reuse them.

■ Do not use the vacuum without an accessory attached. The rim could be damaged and injuries could result from sharp edges.

IMPORTANT SAFETY INSTRUCTIONS

Maintenance and care

■ A damaged power cord must only be replaced with a genuine Miele cord by an authorized service agent.

■ Do not leave the vacuum plugged in. Unplug from the outlet when not in use and before servicing.

■ Do not put any object into openings. Do not use with any opening blocked; keep free of dust, lint, hair, and anything that may reduce air flow.

■ Clean only with a dry or slightly damp cloth when disconnected from the power supply. Never immerse in water.

■ The suction hose and the telescopic wand contain electrical wires. The plug connectors must not come in contact with water. These items may only be cleaned with a dry cloth, no moisture must touch them. Danger of electric shock.

■ This appliance is equipped with a power cord reel. Hold plug when rewinding onto cord reel. Do not allow plug to whip when rewinding.

■ Do not attempt any repairs other than those listed under "Maintenance." Other repairs should be performed by an authorized Miele Service Agent.

The manufacturer can not be held responsible for any work performed by an unauthorized servicer.

Disposal

■ When disposing of an old appliance, the power cord should be removed. Unplug the vacuum. Cut the power cord off the appliance as close to the vacuum as possible and cut the plug off the cord. The plug cut from the cord should be disabled and thrown away. Under no circumstance should this plug be inserted into a socket (electric shock hazard.)

SAVE THESE INSTRUCTIONS

INSTRUCTIONS IMPORTANTES SUR LA SÉCURITÉ

Lorsque vous utilisez un appareil électrique, vous devez toujours prendre des précautions essentielles, y compris ce qui suit.

LISEZ TOUTES LES INSTRUCTIONS AVANT D'UTILISER CET APPAREIL.

Le fabricant n'est pas responsable des dommages causés par le non-respect des présentes instructions.

ATTENTION-

Afin de réduire le risque d'incendie, de choc électrique ou de blessures :

Avant l'utilisation

■ Vérifiez la tension nominale de l'aspirateur avant de le brancher. La tension électrique de votre résidence doit correspondre à celle qui est indiquée sur la plaque signalétique située sous l'aspirateur. N'utilisez que des prises domestiques de courant alternatif. N'utilisez jamais de prise de courant continu. Si vous ne connaissez pas le type d'alimentation électrique de votre résidence, consultez un électricien qualifié. Si vous branchez votre aspirateur à une source d'alimentation électrique de tension supérieure à celle indiquée dans les présentes instructions, vous pourriez endommager l'appareil ou vous blesser.

■ Afin de réduire le risque de choc électrique, cet appareil est muni d'une fiche polarisée (l'une des broches est plus large que l'autre). La fiche ne peut être insérée que d'un seul côté. Si vous n'arrivez pas à l'insérer entièrement dans la prise, retournez-la. Si vous ne pouvez toujours pas l'insérer même après l'avoir retournée, faites appel à un électricien qualifié pour faire installer une prise appropriée. Ne modifiez d'aucune façon la fiche.

■ Un aspirateur endommagé peut s'avérer dangereux. Vérifiez bien l'emballage, l'appareil lui-même et les accessoires pour constater des dommages éventuels. N'utilisez pas d'appareil endommagé.

■ N'utilisez pas l'appareil avec un cordon d'alimentation ou une fiche endommagés. Si l'appareil ne fonctionne pas correctement, s'il a subi une chute ou un dommage, s'il a été laissé à l'extérieur ou s'il a été immergé dans l'eau, faites-le vérifier dans un centre de service technique.

INSTRUCTIONS IMPORTANTES SUR LA SÉCURITÉ

Utilisation

■ N'utilisez pas l'appareil pour nettoyer des personnes ou des animaux.

■ N'utilisez pas l'appareil à l'extérieur ou pour nettoyer des surfaces mouillées. Ne nettoyez que des surfaces **sèches**.

■ Pour utiliser l'aspirateur, suivez uniquement les instructions d'utilisation contenues dans le présent manuel. N'utilisez que les accessoires Miele recommandés.

■ Le fabricant décline toute responsabilité quant à des dommages causés par la non-conformité aux présentes instructions. Cet appareil est destiné uniquement à l'usage domestique.

■ L'appareil ne doit être utilisé en aucun cas pour contenir, circonscrire ou aspirer les spores de la maladie du charbon ou toute autre substance chimique ou biologique dangereuse. Le filtre HEPA de Miele retient les particules microscopiques, mais lorsqu'une substance nocive pour l'organisme s'introduit dans l'appareil, celle-ci contamine l'aspirateur en entier, les embouts, le tube et le tuyau, qui deviennent tous des dangers biologiques. Par la suite, l'appareil contaminé et l'endroit où il a été utilisé devront être signalés aux Centers for Disease Control and Prevention (CDC) pour procéder à l'élimination des dangers biologiques.

Sécurité des enfants

■ Ne laissez pas les enfants jouer avec l'aspirateur. Si un enfant l'utilise ou si vous l'utilisez dans un endroit où se trouvent des enfants, soyez vigilant.

Utilisation quotidienne

■ Ne tirez pas sur le cordon d'alimentation pour transporter l'appareil, n'utilisez pas le cordon d'alimentation comme poignée, ne fermez pas une porte sur le cordon d'alimentation, ne le passez pas sur des extrémités ou des recoins tranchants. Ne passez pas l'appareil sur le cordon d'alimentation. Veillez à ce que le cordon d'alimentation ne se trouve pas à proximité de surfaces chaudes.

■ Le tuyau d'aspiration et le tube télescopique renferment des fils électriques. N'utilisez pas l'aspirateur si ces pièces sont endommagées, coupées ou perforées. Danger de choc électrique!

■ Ne tirez pas sur le cordon d'alimentation pour débrancher l'appareil. Pour le débrancher, tirez sur la fiche et non sur le cordon d'alimentation.

■ Ne manipulez pas la fiche ou l'aspirateur avec des mains mouillées.

■ Veillez à ce que vos cheveux, vos vêtements - s'ils sont amples - vos doigts et toutes les autres extrémités de votre corps ne se trouvent pas à proximité des ouvertures et des parties motrices de l'appareil.

INSTRUCTIONS IMPORTANTES SUR LA SÉCURITÉ

■ Mettez hors service toutes les commandes avant de débrancher l'appareil.

■ Redoublez d'attention lorsque vous nettoyez un escalier.

■ N'utilisez pas les brosses à parquet, les accessoires et les tubes à hauteur de la tête pour éviter des blessures aux yeux et aux oreilles.

■ N'utilisez pas l'appareil pour éponger des liquides inflammables ou combustibles, tels que l'essence, ou dans des pièces où de tels liquides pourraient être entreposés.

■ N'utilisez pas l'aspirateur pour éponger des liquides, car cela pourrait nuire à la sécurité électrique de l'appareil. Attendez que les tapis fraîchement lavés soient secs.

■ N'utilisez pas l'aspirateur pour ramasser un objet brûlant ou fumant, tel que cigarettes, allumettes ou cendres encore chaudes.

■ N'aspirez pas des articles lourds, durs ou ayant des bords tranchants ou pointus. Ils pourraient boucher et endommager l'appareil.

■ Ne nettoyez pas de l'encre en poudre avec l'aspirateur. L'encre en poudre utilisée pour les imprimantes et les photocopieurs peut être conductrice d'électricité.

■ Éteignez toujours l'aspirateur avant de mettre ou d'enlever l'électrobrosse, la turbobrosse ou un accessoire.

■ N'utilisez pas l'aspirateur sans le sac à poussière ou les filtres. Ne faites fonctionner l'aspirateur que si le sac à poussière, le filtre du réservoir à poussière et le filtre d'évacuation sont bien en place. N'utilisez que des sacs à poussière doublés et des filtres Miele (consultez la section « Entretien » pour les instructions d'insertion du sac à poussière et des filtres). Si vous n'avez pas inséré un sac à poussière, le couvercle du réservoir à poussière ne se refermera pas. Ne le forcez pas !

■ Pour aider à dissiper la chaleur produite si vous faites fonctionner l'aspirateur pendant plus d'une heure, l'enrouleur de cordon automatique doit être désactivé et le cordon d'alimentation doit être déroulé de l'enrouleur aux deux tiers au moins.

■ L'aspirateur est muni d'un limiteur de température qui éteint automatiquement l'appareil s'il chauffe trop. Consultez la section portant sur la résolution de problèmes.

■ Pour absorber la charge électrostatique qui se produit lorsque l'aspirateur fonctionne, une pièce métallique est placée sous la poignée de l'appareil. Assurez-vous que votre main enveloppe bien cette pièce métallique.

INSTRUCTIONS IMPORTANTES SUR LA SÉCURITÉ

Utilisation des accessoires

■ L'électrobrosse Miele est un accessoire électrique utilisable uniquement avec les aspirateurs Miele. Elle ne doit pas être utilisée avec des aspirateurs d'une marque autre que Miele.

■ Lorsque vous nettoyez avec l'électrobrosse ou la turbobrosse Miele, ne touchez pas la brosse rotative.

■ Lorsque vous utilisez l'aspirateur avec l'électrobrosse et un tuyau porteur de courant - Le tuyau contient des fils électriques. N'utilisez pas le tuyau s'il est endommagé, perforé ou s'il porte des entailles. Évitez d'aspirer des objets tranchants.

■ La prise de l'aspirateur ne doit servir que pour l'électrobrosse Miele destinée à cet appareil.

■ Utilisez uniquement des accessoires désignés par Miele. N'utilisez pas la soufflerie pour faire fonctionner des pistolets à peinture ou des dispositifs semblables qui émettent des substances volatiles ou toxiques.

■ Surveillez le voyant de remplissage du sac et vérifiez régulièrement tous les filtres. Afin d'assurer une succion efficace, nettoyez-les ou remplacez-les, lorsque nécessaire, selon les instructions d'utilisation. Pour garantir la sécurité de l'appareil, utilisez uniquement des sacs à poussière, filtres et accessoires originaux de Miele.

■ Les sacs à poussière Miele sont jetables et sont conçus pour usage unique. Ne les réutilisez pas.

■ N'utilisez pas l'aspirateur sans accessoire. Vous pourriez endommager le pourtour et vous blesser en touchant l'extrémité coupante.

Entretien

■ Si le cordon d'alimentation est endommagé, ne le remplacez que par un cordon d'alimentation original Miele que vous pouvez vous procurer chez un agent de service technique autorisé.

■ Ne laissez pas l'aspirateur branché. Débranchez-le lorsque vous ne l'utilisez pas et avant de procéder à son entretien.

■ Ne placez aucun objet dans aucune des ouvertures. N'utilisez pas l'aspirateur si une des ouvertures est bloquée. Veillez à ce que poussière, peluches, cheveux ou autres n'obstruent pas l'aspirateur, ce qui pourrait réduire le débit d'air.

INSTRUCTIONS IMPORTANTES SUR LA SÉCURITÉ

■ Nettoyez l'aspirateur seulement avec un tissu sec ou légèrement humide lorsqu'il est débranché. Ne l'immergez jamais dans l'eau.

■ Le tuyau d'aspiration et le tube télescopique renferment des fils électriques. Les prises mâles ne doivent pas se trouver en contact avec de l'eau. Ces éléments peuvent être nettoyés seulement avec un tissu sec et non humide. L'humidité constitue un risque de choc électrique.

■ Cet appareil est muni d'un enrouleur. Tenez la fiche lorsque vous rembobinez le cordon d'alimentation et ne la laissez pas fouetter le plancher.

■ Ne procédez pas à des réparations à l'exception de celles précisées dans la section « Entretien ». Toute autre réparation devrait être effectuée par un agent de service technique autorisé. Le fabricant ne peut être tenu responsable de réparations effectuées par un technicien non autorisé.



Mise au rebut

■ Avant de jeter un vieil aspirateur, vous devez couper le cordon d'alimentation. Débranchez l'aspirateur, coupez le cordon le plus près possible de l'appareil ainsi que la fiche. La fiche doit être mise hors d'état de fonctionner et jetée. En aucun cas vous ne devez brancher cette fiche dans une prise (risque de choc électrique).

VEUILLEZ CONSERVER CES INSTRUCTIONS

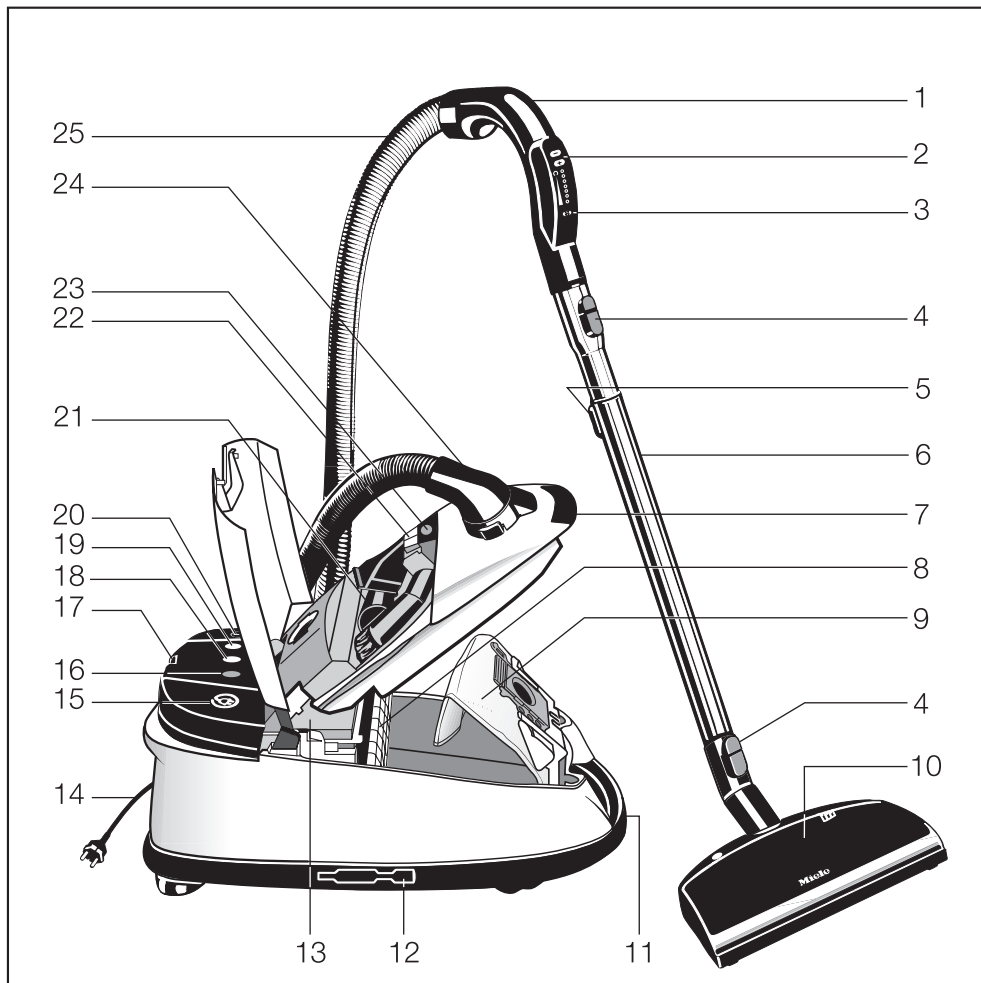
Guide to the vacuum cleaner



- ① Handpiece
- ② Suction power selector
- ③ Electrobrush switch
- ④ Locking button
- ⑤ Telescopic wand release button
- ⑥ Telescopic wand
- ⑦ Dust compartment lid release
- ⑧ Dust compartment filter (motor protection)
- ⑨ Dust bag
- ⑩ Electrobrush
- ⑪ Carrying handle
- ⑫ Suction wand holder
- ⑬ Exhaust filter
- ⑭ Power cord with plug
- ⑮ Cord rewind switch
- ⑯ Exhaust filter change indicator (Re-set button )
- ⑰ Park-System
- ⑱ Stand-by light
- ⑲ Thermo indicator 
- ⑳ On / Off switch
- ㉑ Accessories compartment
- ㉒ Dustbag change indicator
- ㉓ Accessory compartment lid release
- ㉔ Elbow
- ㉕ Suction hose

Before using for the first time

Attaching the suction hose

- Open the dust compartment shutter.

The dust compartment shutter is designed for clean handling and prevents dust and odors from escaping. If you remove the suction hose from the vacuum cleaner for storage purposes close the dust compartment shutter before putting it away.

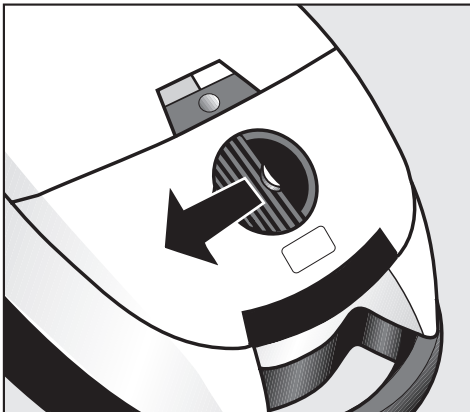

- Insert the elbow into the suction socket.

When inserting the elbow ensure that the plug connectors line up correctly.

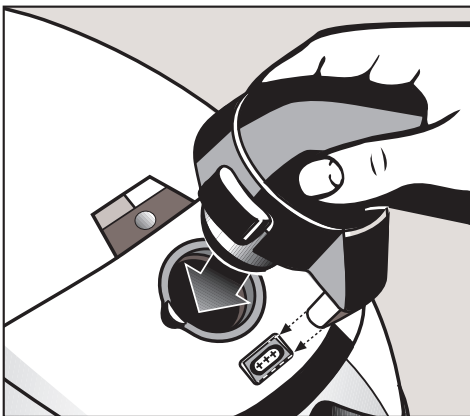

Removing the suction hose

- Press the release buttons at the side of the elbow and lift the hose from the socket.

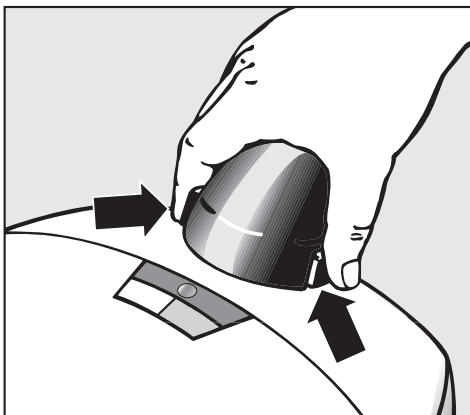

Connecting the suction hose and the suction wand

- Fit the handpiece of the suction hose firmly into the suction wand. (Ensure that the plug connectors line up.) They must lock together with a click.
- To release the handpiece from the suction wand press the locking button and pull apart (see arrow).

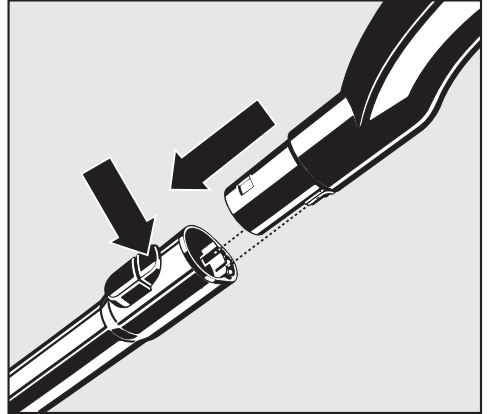



Adjusting the suction wand

One part of the telescopic wand is inside the other and can be adjusted to your height for comfortable vacuum cleaning.

To adjust

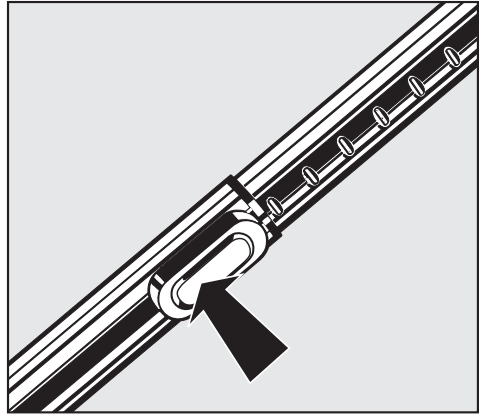
- Press the telescopic wand release button (see arrow) to release the tubes. Draw out or push in the inner tube to adjust to the height, then release the button. The wand is locked in position.



 When a resistance is felt it has reached its maximum length. Do not force it beyond this length!

Before using for the first time

Using the Electrobrush

The Electrobrush is particularly suitable for cleaning and restoring crushed carpet pile of wall to wall carpeting and floor coverings subject to hard wear, especially in high traffic areas.

The SEB 217, SEB 226 and SEB 236 are compatible with this vacuum. The Electrobrush can also be used on smooth flooring surfaces.

The standard floor brush (optional accessory) or the Miele parquet floorbrush should be used to clean delicate hard flooring and floor surfaces susceptible to scratching.

Do not use the powerbrush on:

- Floors with a variable or uneven surface. The brush might come into contact with the floor and cause damage.
- High quality, hand knotted rugs, for example Berber or Persian rugs, as well as extremely long piled area rugs and carpets. There is a danger of the threads being pulled out. Turn the Electrobrush off to vacuum these types of floor coverings and use only suction.

Attaching the Electrobrush to the vacuum cleaner

- Insert the telescopic wand into the Electrobrush. (Ensure that the plug connectors line up). They must lock together with a click.

For more information on use and maintenance please refer to the instructions supplied with the Electrobrush.

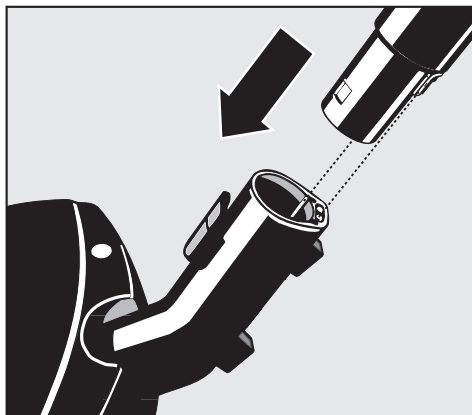

Before using for the first time

Using the parquet floor brush

Special brush with natural bristles for cleaning parquet and laminate floors, floorboards and flooring susceptible to scratching (e.g. with a high shine).

Regard primarily the Cleaning and Care instructions of the floor covering manufacturer.

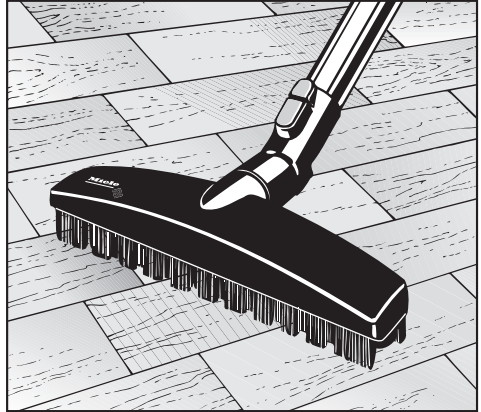

Attaching the parquet floor brush

- Push the telescopic wand into the floor brush and turn clockwise or counterclockwise until it clicks into position.
- To release the parquet floor brush from the telescopic wand, press the locking button (see arrow) and pull the wand out of the floor brush.

The adapter **A** is inserted to use the suction wand holder on the vacuum canister. This allows the vacuum to be transported or stored in an upright position. See "Description of the appliance" Line 12.

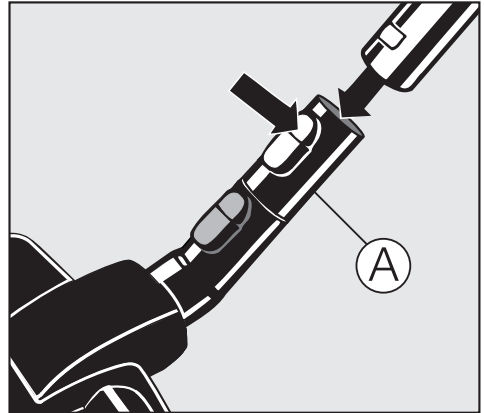

Included accessories

Other tools, in addition to the floor brush(es), are supplied with the vacuum cleaner to help with various types of cleaning.

- ① **Crevice nozzle**
- ② **Crevice nozzle extension ***
- ③ **Dusting brush with natural bristles**
- ④ **Upholstery brush**
- ⑤ **Filter grill**
(supplied separately in the box)
- ⑥ **Blower connection socket, not illustrated**
(see "Operation")

* only for S 658

The filter grill ⑤ is required if you wish to replace the "ACTIVE HEPA" filter with a "SUPER air clean" filter.

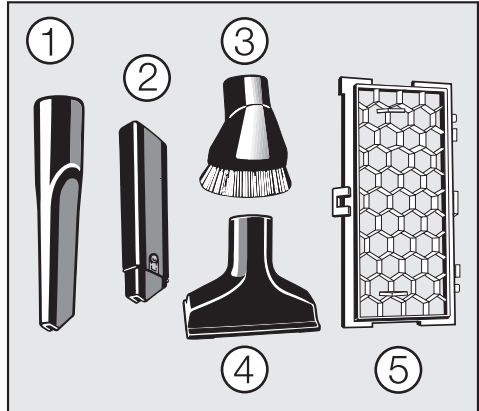

Taking the accessories out

- Press the release button to open the accessory compartment lid.

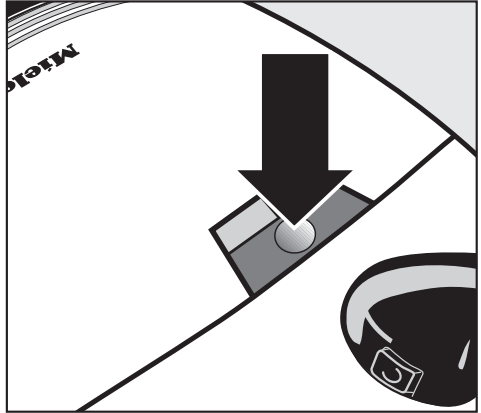

- Take out the accessory needed.
- Close the lid securely.

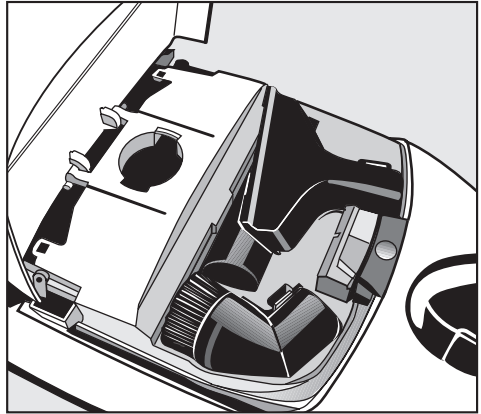

Crevice nozzle extension

(only for the S 658)

The crevice nozzle extension is located in the compartment underneath the crevice nozzle.

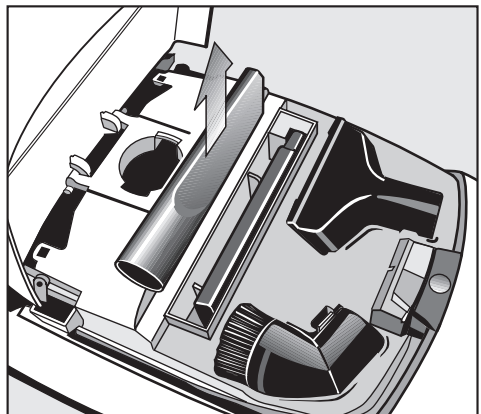

Using the included accessories

The different tools can either be fitted to the handpiece or to the suction wand.

Crevice nozzle

For cleaning in folds, crevices and corners.

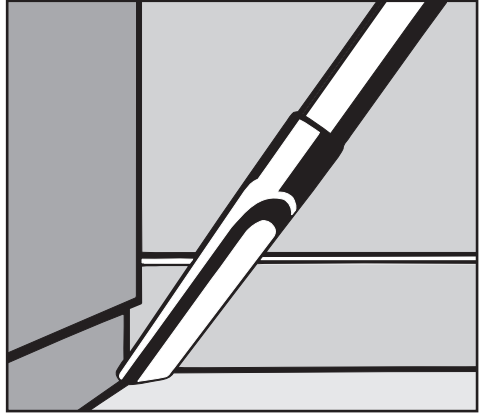

Crevice nozzle extension

(only with model S 658)

This accessory can be used to extend the length of the crevice nozzle. Further length is provided by pulling out the inner section.

- Press the locking button to pull the extension piece out or to push it in.

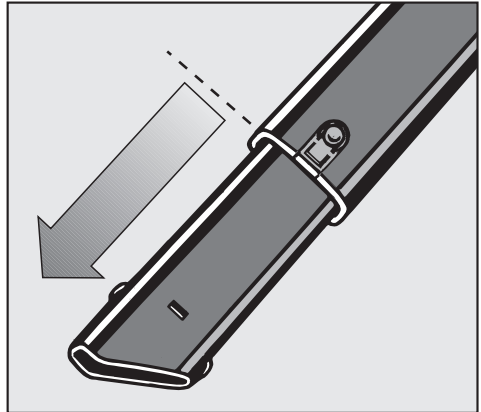

Using the included accessories

Dusting brush

For cleaning moldings, ornate or carved articles, etc.

The head of the dusting brush can be swivelled to attain the best cleaning position.



Upholstery nozzle

For cleaning upholstery, mattresses, cushions, covers etc.



Operation

Unwinding and rewinding the power cord

Unwinding

- Hold the plug and pull out the power cord to the required length:
S 558: maximum 24 ft. (7.5 m)
S 658: maximum 31 ft. (9.5 m)

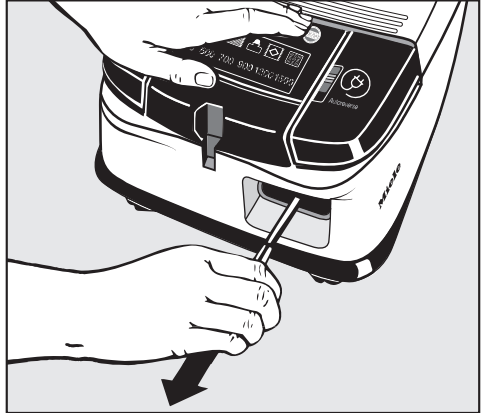

⚠ If the vacuum cleaner is operated more than 30 minutes the power cord must be unwind at least two thirds of the way. To reduce the risk of electric shock, the vacuum has a polarized plug (one blade is wider than the other). This plug will fit in a polarized outlet only one way. If the plug does not fit fully in the outlet, reverse the plug. If it still does not fit, contact a qualified electrician. Do not alter the plug in any way. Danger of over-heating and damage.

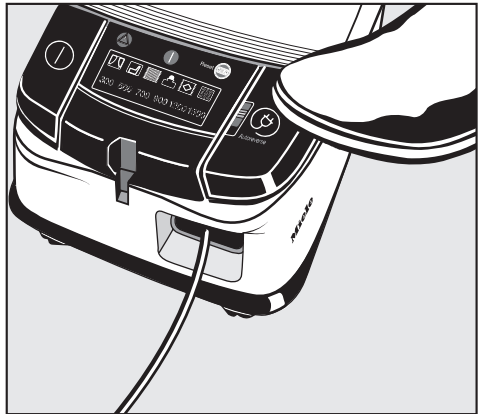

Rewinding

- Unplug the vacuum from the outlet.
- Press the rewind button and the power cord will rewind automatically.

Auto-reverse

To use this function, move the slide switch to "Auto-Reverse". This releases the cable reel brake and allows the spring loaded reel to take up the slack between the vacuum and the outlet.

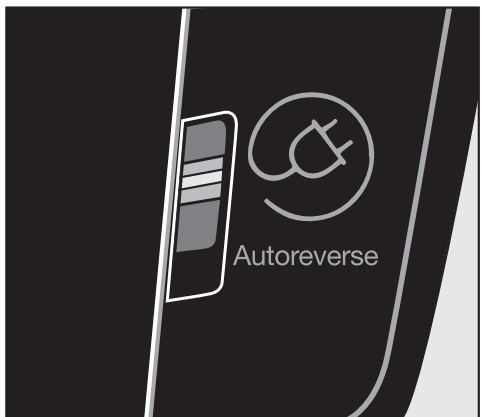

Turning the vacuum on and off

To turn the vacuum cleaner on:

- Press the On-Off switch.

The Stand-by indicator light comes on to show that the vacuum cleaner is ready for use.

While vacuuming

The vacuum cleaner can also stand on its end for vacuuming stairs, drapes etc.

Vacuuming fine dust, flour or sawdust can create static charge which can discharge in certain circumstances.

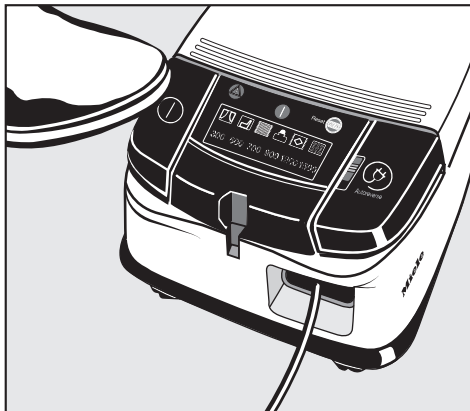

⚠ To prevent static discharge your hand must touch the metal inlay on the underside of the vacuum handpiece. Be certain to continuously touch this inlay when vacuuming fine dust, flour or sawdust as these materials are most likely to create static discharge. To further prevent static discharge while vacuuming, pull the vacuum along by the hose with one hand while continuing to hold the handpiece in the other hand.

To turn the vacuum cleaner off:

- Press the On-Off switch again.

The Stand-by indicator goes out.

⚠ Turn off the vacuum before opening the dust compartment lid. Otherwise the vacuum turns on automatically (this allows the operating mode "Blow").

Operation

Adjusting the suction

■ Turn the vacuum cleaner on.

Use the **+** and **-** on the handpiece to adjust the suction to suit the type of flooring.

Setting **0** = no suction

Low setting = weak suction

High setting = strong suction

The floor brush will require less effort to maneuver when the suction power is reduced. Adjust the suction according to the degree of soiling and type of flooring being cleaned.

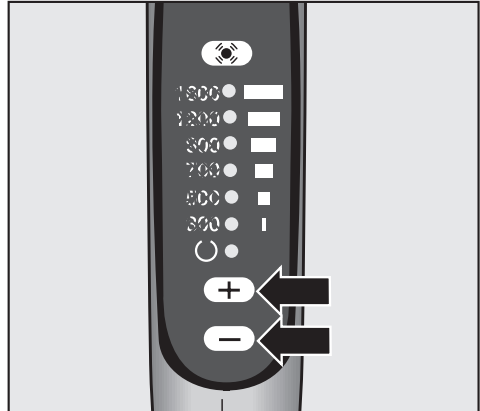

Turning the Electrobrush on and off

The Electrobrush is turned on and off separately from the vacuum cleaner by pressing the  switch on the handpiece.

This means that you can turn the Electrobrush off during vacuuming and the vacuum cleaner will continue to operate using suction only. This is useful, for example when moving from carpeting to a rug.

Selecting setting  also turns the Electrobrush off. To continue vacuuming select a suitable setting.

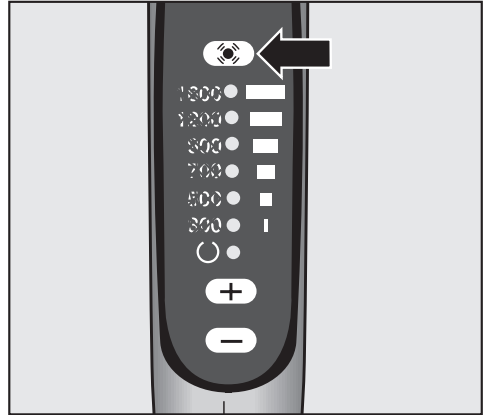

Operation

Blower connection socket

The blower connection socket can be used to connect the suction hose to the "blower" outlet of the vacuum cleaner, e.g. for dusting multi-layered radiators. It can also be used to "blow out" the suction hose if it should ever become blocked.

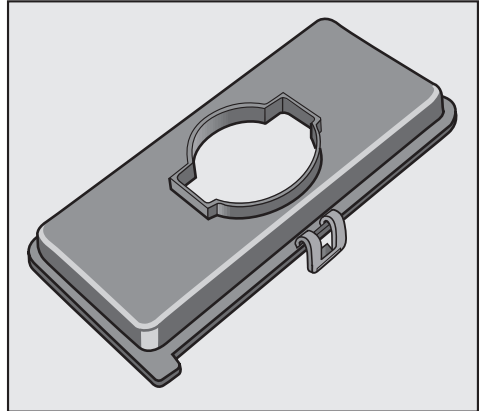

- Ensure that the vacuum cleaner is turned off.
- Press the release button for the dust compartment lid and raise the lid so that it clicks into place.
- Take out the exhaust filter or the filter grill if present and replace with the blower connection socket.
- Close the dust compartment lid.

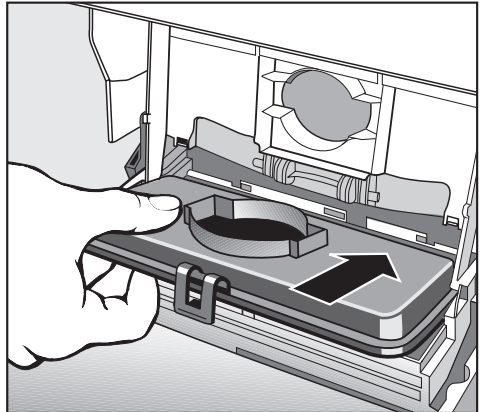

- Open the accessories compartment and insert the elbow of the suction wand into the blower connection socket.
- Turn the vacuum on.

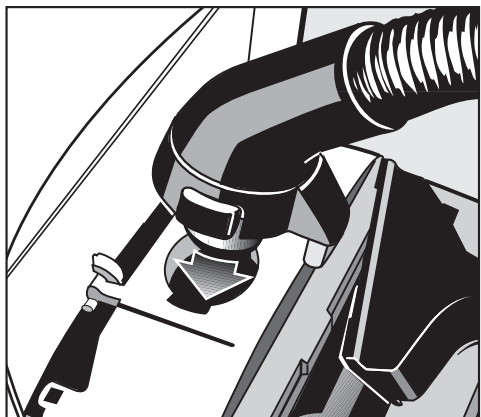

Setting down, transport and storage

Park-System

A Park-System has been designed for conveniently parking the vacuum cleaner during pauses and for carrying as well as for storage. A special parking attachment is fitted to all floor brushes, except the Electrobrush SEB 236 which can stand by itself.

- Insert the lower clip on the floor brush into the slot on the end of the vacuum cleaner from above.

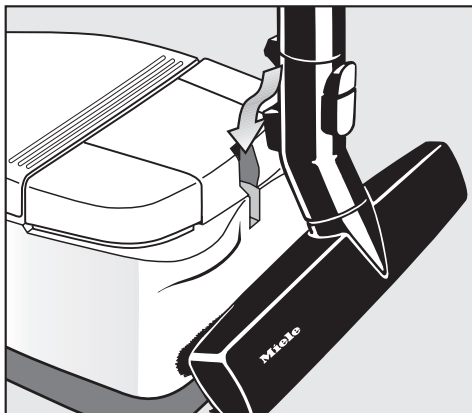

Turning on and off with the Park-System

Parking the floor brush while vacuuming automatically turns off the vacuum without needing to press the On-Off switch. Lifting the floor brush out of the Park-System turns the vacuum back on.

Transport and storage

- Stand the vacuum cleaner vertically.
- Fit both clips on the floor brush into the two point holder on the side of the vacuum.
The adapter (A) has to be inserted when using the standard floor brush, the turbobrush, the hard floor brush and the parquet floor brush.

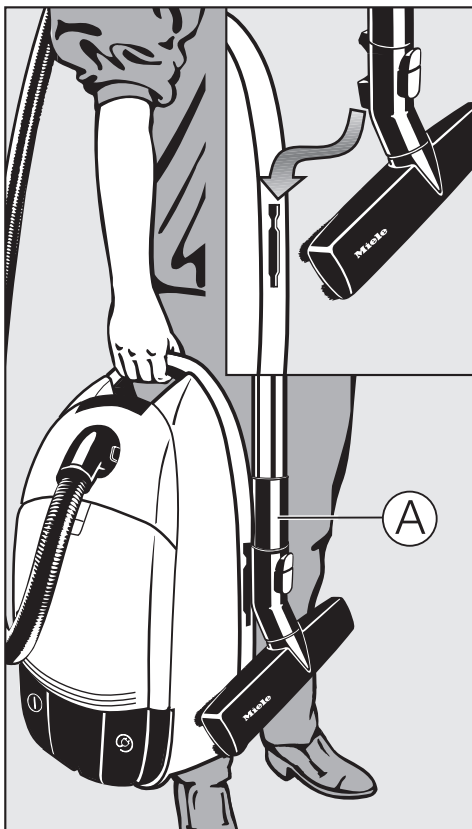

Maintenance and care

 Turn off the vacuum and unplug it from the outlet before performing any maintenance work.

The Miele filter system consists of three filters which must be replaced from time to time to ensure efficient suction.

- Dustbag (filter bag)
- Exhaust filter
- Dust compartment filter (motor protection).

Use only genuine Miele dustbags and filters, making sure they are the correct ones for your model. This ensures optimum performance of the suction power and also ensures that the bag is used to capacity.

Purchasing new dustbags and filters

Replacement dustbags and filters can be obtained from your local Miele Dealer.

Order original Miele dustbags with the letter:

- **F/J/M** for model S 558
- **G/N** for model S 658

You will find the model number given on the data plate located underneath the appliance.

A "SUPER air clean" exhaust filter and a dust compartment filter are supplied with every box of Miele dustbags.

If you wish to purchase exhaust filters or dust compartment filters separately, please quote the model number of your appliance when ordering.

The "ACTIVE HEPA" filter supplied with the vacuum can be replaced by a "SUPER air clean" or an "ACTIVE air clean" filter if you wish (see "Replacing one type of filter with another").

When to change the dustbag

Change the dustbag when the colored marker in the dustbag change indicator fills the display.

Miele dust bags are disposable and intended to be used only once. Do not attempt to reuse.

Checking the dustbag change indicator

- Attach the floor brush to the vacuum cleaner. Only test with the floor brush, since other attachments can affect the function of the dustbag change indicator.
- Turn the vacuum cleaner on and select the highest power setting.
- Lift the floor brush off the floor a little. If the marker completely fills the indicator window, then the bag needs to be changed.

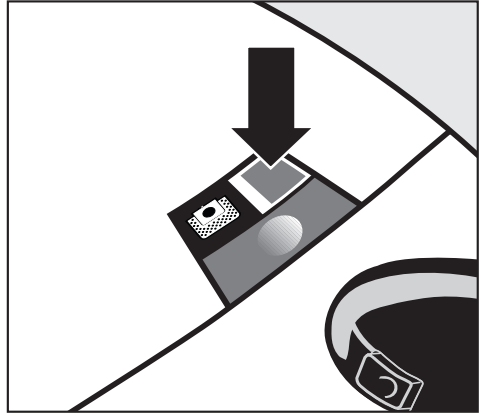

How the dustbag change indicator works

The indicator is designed to show when the bag is full of common household dust and works by measuring the air permeability of the dustbag. Normal household dust is a mixture of dust, hair, carpet fluff, threads, sand etc.

However, if fine dust, such as drill dust, sand, plaster or flour is vacuumed, the pores of the dustbag become blocked. The marker will indicate that the bag is "full" even when it is not. In this instance the dustbag must be changed as suction power is reduced when the pores of the dustbag are blocked.

If, on the other hand, a large quantity of hair, wool or carpet fluff is vacuumed, the dustbag change indicator may not register "full" even though the bag is full. This is because the air permeability of the dustbag may still be high enough not to activate the marker to show maximum. The dustbag should still be changed.

Maintenance and care

Replacing the dustbag

- Open the dust compartment lid.

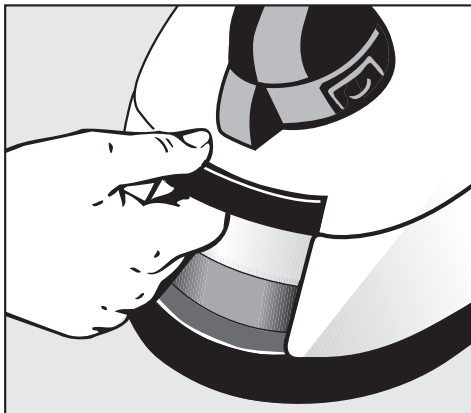

The dustbag has a flap which closes automatically when the dustbag is removed to prevent any dust from escaping.

- Grasp the collar by the two finger holes and pull it out from the dustbag holder.

It can then be thrown out with the household trash as long as it has only been used for vacuuming household dust.

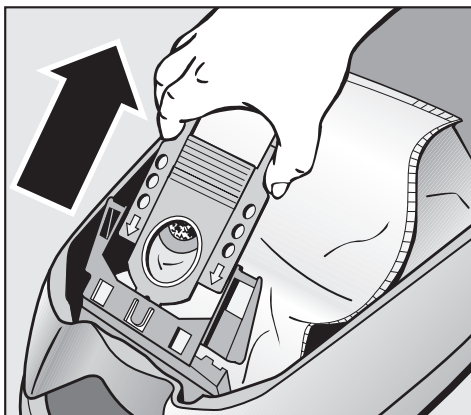

Do not unfold the dustbag when taking it out of the box. Keeping it folded will prevent it from getting caught when the dust compartment lid is closed.

- To insert a new dustbag push the collar securely into the frame as far as it will go. If it is not correctly located the dust compartment lid will not close.
- Close the dust compartment lid firmly until it clicks into place.

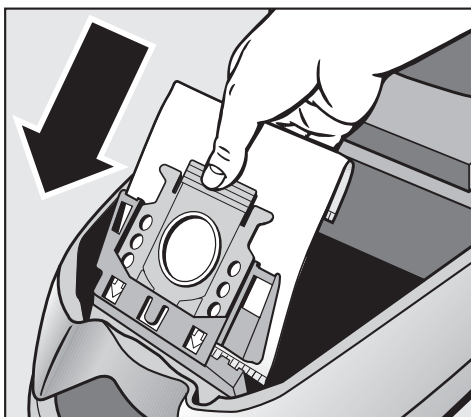

Replacing the exhaust filter

Always change the ACTIVE HEPA filter when the filter change indicator (Reset button ) lights up. It is designed to light up after approximately 50 hours of operation which is about a year of average use. The vacuum cleaner can still be used with the exhaust filter indicator lit. However, the suction power will be reduced as will the effectiveness of the filter if it is not replaced.

You can replace the "ACTIVE HEPA" filter supplied with the cleaner with a "SUPER air clean" or an "ACTIVE air clean" filter if you wish (see "Replacing one type of filter with another").



Maintenance and care

Replacing the "ACTIVE HEPA" filter

- Open the dust compartment lid.
- Release the catch and remove the filter.
- To insert the new filter, fit it so that it engages at the back, then close the catch.
- Close the dust compartment lid firmly until it clicks into place.

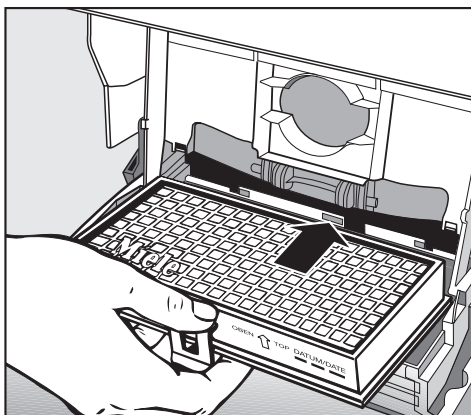
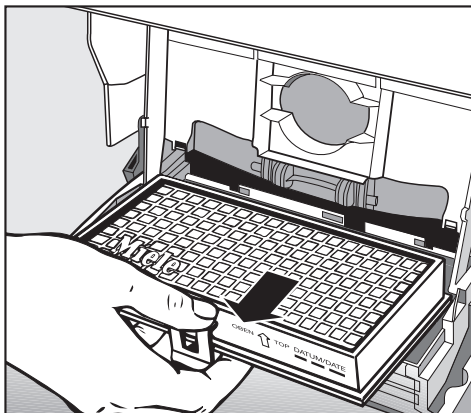

Resetting the filter change indicator

The filter change indicator (Reset button ) needs to be reset each time the filter is replaced. To do this the vacuum cleaner must be plugged in.

- Press the filter change indicator light until it goes out. The display is now back in the starting position.



Replacing one type of filter with another

You can replace the **c** ACTIVE HEPA filter which is fitted as standard to your vacuum cleaner with either:

- a** a SUPER air clean filter or
- b** an ACTIVE air clean filter.

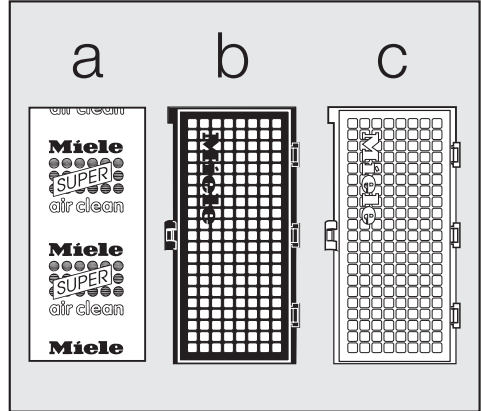

If replacing **c** with **a**, please note:

If you wish to replace the **c** ACTIVE HEPA filter with the **a** SUPER air clean filter you must also insert the filter grill (see "Included accessories").

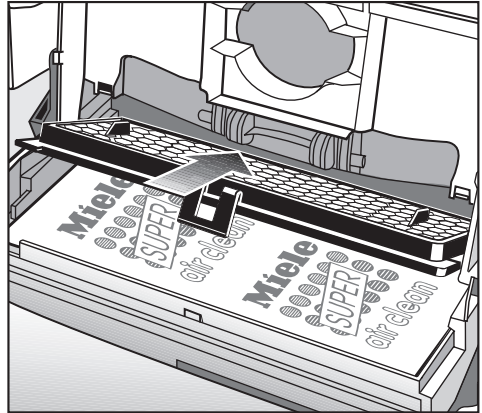

The built-in exhaust filter change indicator (Reset button ) is designed for the change cycle of an ACTIVE air clean or an ACTIVE HEPA filter.

The filter change indicator light will have no significance if a SUPER air clean filter has been fitted. The SUPER air clean filter should be replaced every time you start a new box of dustbags. (A SUPER air clean filter is supplied with every box of Miele dustbags).

Pressing on the filter change indicator light will reset it.



Maintenance and care

When to change the dust compartment filter (motor protection)

Replace the dust compartment filter every time you start a new box of dustbags.

A dust compartment filter is supplied with each box of Miele dustbags.

Replacing the dust compartment filter

- Open the dust compartment lid.
- Open the filter frame, remove the old filter and replace with a new one.
- Close the filter frame.

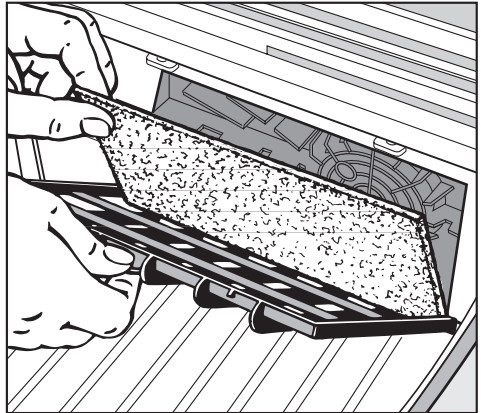

 Turn off the vacuum and unplug it from the outlet when not in use and before service.

Vacuum cleaner and accessories

 The suction hose, the telescopic wand and the electrobrush contain electrical wires and components. The plug connectors must not come in contact with water. These items may only be cleaned with a dry cloth, no moisture must touch them. Danger of electric shock.

External surfaces of the vacuum cleaner and accessories can be cleaned with a dry or slightly damp cloth or with a cleaner for plastic.

 Do not use an abrasive cleaner, a glass or an all purpose cleaner! They will damage the surface.

Dust compartment

The dust compartment can be cleaned using another vacuum, if available, or a **dry** cloth or brush.

Monitor the change dustbag indicator and inspect all filters regularly. Clean or replace them when necessary according to the Operating Instructions.

 Never immerse the vacuum cleaner in water! If moisture gets into the appliance, there is a risk of an electric shock.

Problem solving guide

If the vacuum cleaner switches itself off automatically and the overheating indicator lights up:

A temperature limiter switches the the vacuum cleaner off automatically if it gets too hot. The warning light  will then come on to indicate "Warning - Overheating".

This can occur if, for instance, large items block the suction wand or when the dustbag is full or contains particles of fine dust.

A heavily soiled exhaust or dust compartment filter can also be the cause of overheating.

In this case, turn off the vacuum cleaner using the On-Off switch.

After removing the cause, wait for 20 - 30 minutes, so that the vacuum cleaner can cool. After the cool down period, the vacuum can be used.

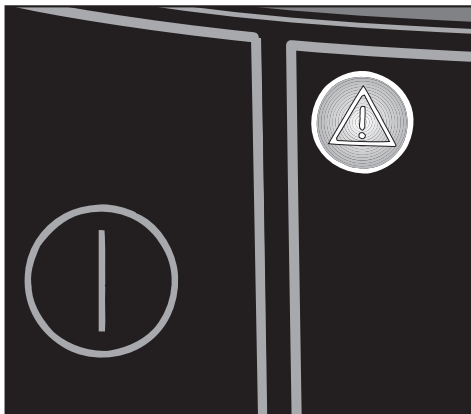

In the event of a fault which you cannot correct, please contact the Miele Technical Service Department.

USA 1-800-999-1360
techserv@mieleusa.com

CDN 1-800-565-6435
service@miele.ca

Optional accessories

Turbobrush STB 205

Recommended for cleaning and restoring crushed pile on low nap rugs or carpeting.

The turbobrush is mechanically driven by the suction power of the vacuum. No electrical connection or electric hose is necessary.

Observe the cleaning instructions of the floor manufacturer.



Hand Turbobrush STB 101

The hand Turbobrush is intended for vacuuming upholstery, mattresses, car seats, carpeted stairs, etc.

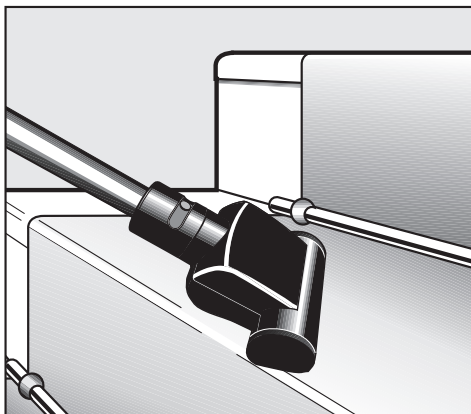

Hard floor brush

For cleaning smooth floors (e.g. stone, ceramic, vinyl).



Standard floor brush

The standard floor brush can be used for normal cleaning of carpets, rugs, and hard surfaces.

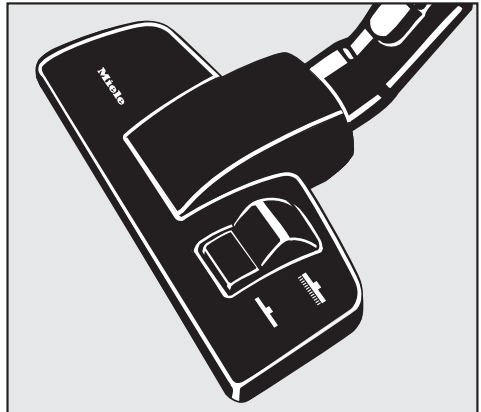

Optional accessories

Radiator brush

For cleaning radiators, narrow shelves or crevices.

- Fit the radiator brush to the crevice nozzle.



Universal brush

For dusting books, shelves, etc.



Mattress tool

For vacuuming mattresses and upholstery. Even deep crevices between mattresses can be vacuumed easily.



Crevice tool 12" (300 mm)

For cleaning in folds, crevices and corners.

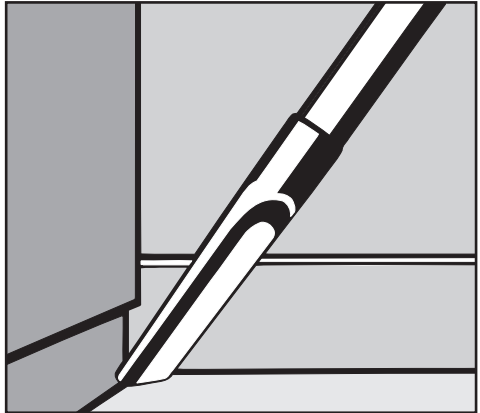

Optional accessories

ACTIVE air clean filter

This is a special active charcoal filter which absorbs odors from dust collected in the dustbag helping to prevent odors.

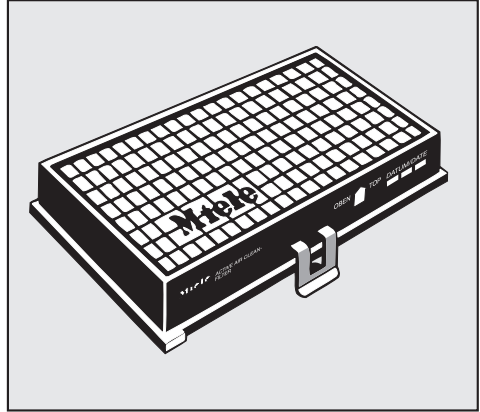

MicroSet

This set is specially designed for cleaning intricate small objects and difficult to reach areas (such as PC keyboards, stereo equipment, carved furniture and ornaments, models etc).

Accessory set consists of:

- micro hose with combi nozzle (crevice nozzle and dusting brush)
- micro dusting brush
- micro crevice nozzle and
- angled extension

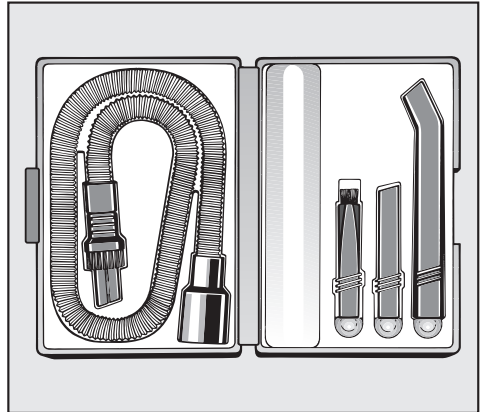

CarClean Set Plus

Specially designed for cleaning narrow crevices, tight upholstery, loose floor mats and tight spaces in a car.

Accessory carrying case consists of:

- the Miele hand turbobrush
- micro hose with Combi nozzle
- crevice nozzle 12" (300 mm)
- a 10 foot (3 m) long suction hose with holder.

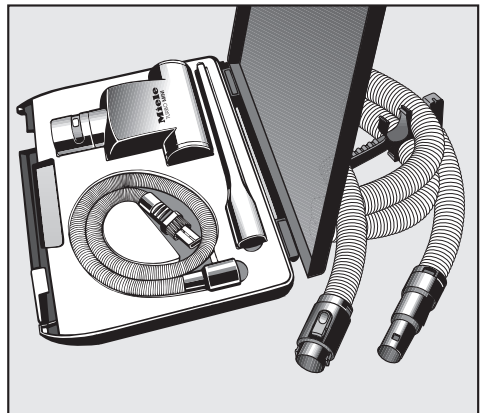

- Connect the vacuum cleaner only to a 120 V, 60 Hz, 15 A outlet.

Caring for the environment

Disposal of the packing materials

The cardboard box and packing materials protect the appliance during shipping. They have been designed to be biodegradable and recyclable.

Ensure that any plastic wrappings, bags, etc. are disposed of safely and kept out of the reach of children. These items pose a danger of suffocation.

Disposing of the dustbag and filters

Genuine Miele dustbags and filters are made of environmentally friendly materials. They can be thrown out with the household trash provided the vacuum has been used only for normal household dust.

When contacting the Technical Service,
please quote the model and serial number
of your appliance.



Miele, Inc. (USA)

National Headquarters

9 Independence Way
Princeton, NJ 08540
Phone: 800-843-7231
609-419-9898
Fax: 609-419-4298
www.mieleusa.com

Technical Service & Support

Nationwide

Phone: 800-999-1360
Fax: 888-586-8056

Mid-West Region

Phone: 800-666-6740
Fax: 847-714-9434

South-East Region

Phone: 561-995-8030
Fax: 561-995-8083

West-Coast Region

Phone: 800-245-8215
Fax: 415-241-6822

Miele Limited (CDN)

National Headquarters

55G East Beaver Creek Road
Richmond Hill, ON L4B 1E5
Phone: 800-643-5381
905-707-1171
Fax: 905-707-0177
www.miele.ca
info@miele.ca (general enquiries)
professional@miele.ca (commercial
enquiries)

Mielecare National Service

Phone: 800-565-6435
905-850-7456
Fax: 905-850-6651
service@miele.ca (Tech. Service)