

Miele

Operating Instructions

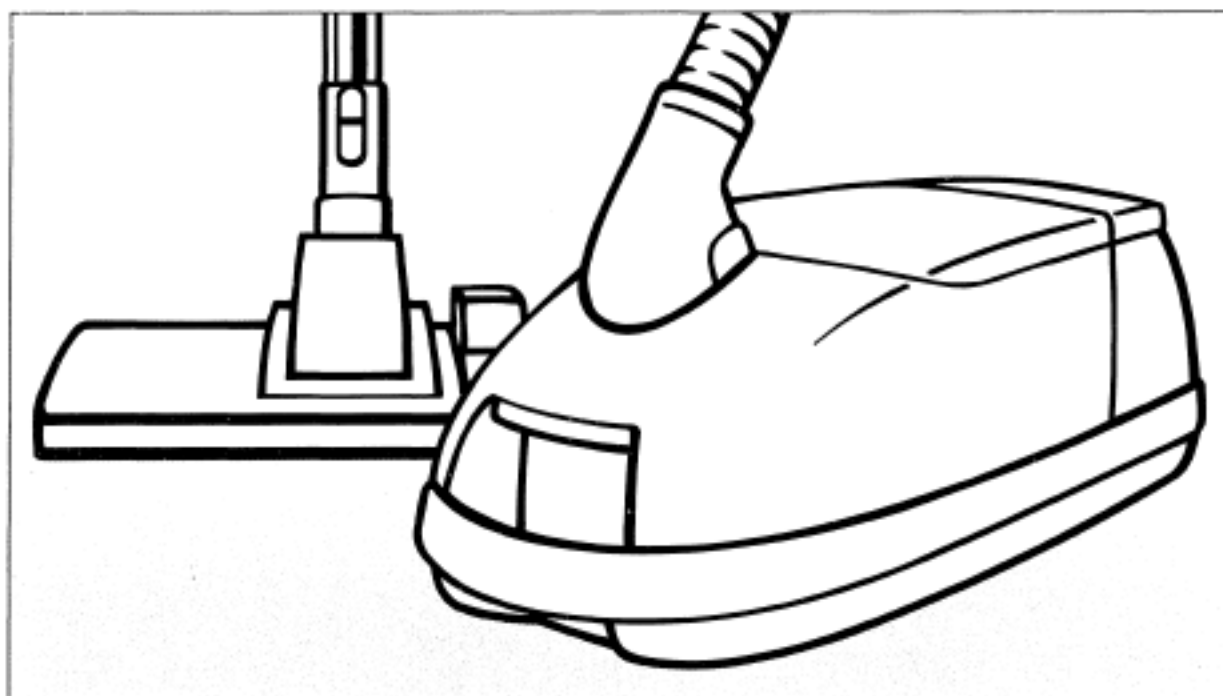

Vacuum Cleaners

S 300i - S 348i

S 400i - S 448i

To prevent accidents and reduce the risk of damaging the vacuum cleaner, read the Operating Instructions **before** using the vacuum cleaner.



M.-Nr. 05 638 520/02

Contents

Description of the appliance	3
Help to protect our environment	4
Important safety instructions	5
Preparing for use	9
Included accessories	13
– Radiator brush	14
– Crevice nozzle	14
– Dusting brush	14
– Upholstery nozzle	15
– Blower connection socket	15
Operation	17
– Unwinding and rewinding the power cable	17
– Switching on and off	18
– Regulating the suction	18
– Air inlet valve	21
– Park-System	22
– Transportation and storage	22
– Suction level indicator	23
Maintenance and care	24
– When to change dustbag and filters	24
– How to change dustbag and filters	26
– Changing the thread catcher pads	29
Cleaning and care	30
Problem solving guide	31
Electrical connection	32
Optional accessories	33

The illustration shows the maximum number of features available on Miele vacuum cleaners.

Separate Operating Instructions for the Powerbrush and Electric Hose (not shown) are included with models featuring these items.

Those features marked* depend on the model and may vary or not be available on your model.

Description of the appliance



- 1 Power cable
- 2 Park-System*
- 3 Cable rewind
- 4 Suction power selector*
- 5 Overheating warning light*
- 6 On/Off switch
- 7 Exhaust filter*
- 8 Blower socket
- 9 Suction level indicator
- 10 Release button for accessories compartment
- 11 Hand piece

- 12 Air inlet valve
- 13 Locking button
- 14 Suction wand*
- 15 Elbow
- 16 Dust compartment lid catch
- 17 Slide control*
- 18 Dust compartment filter
- 19 Dustbag
- 20 Socket for Electro Brush*
- 21 Floorbrush*
- 22 Carrying handle
- 23 Suction wand holder

Help to protect our environment

Disposal of the packing material

The vacuum box and packaging material protects the appliance during shipping. It has been deliberately designed to be biodegradable and recyclable. Please dispose of these materials as you would any other recyclable products.

Disposal of your old machine

Old machines contain materials which can be recycled. Please contact your recycling center or scrap merchant before disposing of the appliance. Before disposal, make the machine inoperative and child resistant by cutting off the power cord.

Disposal of the dustbag and filter

Genuine Miele dustbags and filters are made from environmentally friendly materials. Filters can be disposed of along with your normal household trash, as can dustbags, provided that the vacuum has not been used on restricted materials.

IMPORTANT SAFETY INSTRUCTIONS

When using an electrical appliance, basic precautions should always be followed, including the following:

READ ALL INSTRUCTIONS BEFORE USING THIS APPLIANCE

WARNING-

To reduce the risk of fire, electric shock or injury:

Before using

Check the voltage rating of the vacuum cleaner before connecting the power cord to an electrical outlet. Your power source should correspond with the voltage rating plate located on the underside of the vacuum. Use only household AC outlets. Never use DC power sources. If you are not sure of your home's voltage supply, consult a qualified electrician. Connecting the vacuum cleaner to a higher voltage than indicated in these instructions may result in damage to the vacuum cleaner or injury.

To reduce the the risk of electric shock, this appliance has a polarized plug (one blade is wider than the other.) This plug will fit in a polarized outlet only one way. If the plug does not fit fully in the outlet, reverse the plug. If it still does not fit, contact a qualified electrician to install the proper outlet. Do not change the plug in any way.

A damaged vacuum cleaner can be dangerous. Check the packaging, the vacuum cleaner and accessories for any signs of damage. Do not use a damaged appliance.

Do not use with a damaged cord or plug. If the appliance is not working as it should, has been dropped, damaged, left outdoors or immersed in water, bring it to a service center.

Use

Do not use on people or on animals.

Do not use outdoors or on wet surfaces. Only **dry** surfaces should be vacuumed.

Use only as described in this manual. Use only Miele recommended accessories.

The manufacturer cannot be held responsible for damage caused by non-compliance with these Important Safety Instructions. This appliance is intended strictly for household use only.

Under absolutely no circumstances should this vacuum cleaner be used to arrest, retain and/or contain the anthrax virus or any other hazardous chemical or biological particles. While Miele's HEPA filter is certified to retain micro-particles, once any biohazardous material is introduced into the vacuum, the entire vacuum cleaner unit, floor tools, wand, and hose become contaminated, rendering them all a bio-hazard.

Thereafter, this contaminated appliance and the entire environment would require the attention of the Center for Disease Control and Prevention (CDC) to employ biohazard cleanup procedures.

Child safety

Do not allow the vacuum cleaner to be used as a toy. Close attention is necessary when used by or near children.

Daily use

Do not pull or carry by the cord, use the cord as a handle, close a door on the cord, or pull the cord around sharp edges or corners. Do not run the appliance over the cord. Keep the cord away from heated surfaces.

Do not unplug by pulling on the cord. To unplug, grasp the plug, not the cord.

Do not handle the plug or vacuum with wet hands.

Keep hair, loose clothing, fingers and all parts of the body away from openings and moving parts.

Turn off all controls before unplugging.

Use extra care when cleaning on stairs.

Floor attachments, accessories and wands must not be used at head level to avoid injury to eyes and ears.

Do not use to pick up flammable or combustible liquids, such as gasoline, or use in areas where they may be present.

Do not use the vacuum cleaner to pick up liquids, as this could impair the electrical safety of the vacuum cleaner. This applies to freshly shampooed carpets. Wait until they dry.

Do not pick up anything that is burning or smoking, such as cigarettes, matches, or hot ashes.

Do not vacuum toner dust. Toner, such as that used in printers and photocopiers can conduct electricity.

Always turn off the vacuum before connecting or disconnecting the Electrobrush, Turbobrush or accessories.

Do not use without dustbag and/or filters in place.

Do not turn on or attempt to operate the vacuum cleaner unless a dustbag, dust compartment filter and exhaust filter are in place. Use only genuine Miele double-layer dustbags and filters (see [Maintenance](#) for instructions on how to insert the dustbag and filters.) If a dustbag has not been inserted, the dust compartment cover will not close. Do not use force!

To aid the vacuum in dissipating heat during extended operation (longer than 1 hour), the Auto-Reverse feature should be turned off and the power cord should be unwound from the cable reel at least two thirds of the way.

A temperature limiter automatically switches off the vacuum cleaner if it gets too hot, see [Problem solving guide](#).

On the underside of the vacuum hand piece is a metal insert designed to absorb electrostatic charge. Please make certain that your hand remains around this metal insert.

Accessory use

The Miele Electrobrush is a motor driven accessory for use only with Miele vacuum cleaners. It must not be used with vacuum cleaners produced by other manufacturers.

When vacuuming with the Miele Electrobrush or Turbobrush, do not touch the rotating brush.

When vacuuming with the Miele Electrobrush or Turbobrush, do not touch the rotating brush.

When using the vacuum with an Electrobrush and current-carrying hose: The hose contains electrical wires. Do not use when damaged, cut, or punctured. Avoid picking up sharp objects.

The socket on the vacuum cleaner (depending on model) must only be used for the Miele Electrobrush specified for use with this appliance.

Use only attachments specified by Miele. Do not use the blower to operate paint sprayers or similar devices that emit volatile or toxic vapors.

Monitor the dustbag change indicator and inspect all filters regularly. To ensure efficient suction, clean or replace them when necessary according to the operating instructions. To guarantee safety, only use genuine Miele dustbags, filters and accessories.

Miele vacuum cleaner bags are disposable and intended to be used only once. Do not attempt to reuse them.

Do not use the vacuum without an accessory attached. The rim could be damaged and injuries could result from sharp edges.

Maintenance and care

A damaged power cord must only be replaced with a genuine Miele cord by an authorized service agent.

Do not leave the vacuum plugged in. Unplug from the outlet when not in use and before servicing.

Do not put any object into openings. Do not use with any opening blocked; keep free of dust, lint, hair, and anything that may reduce air flow.

Clean only with a dry or slightly damp cloth when disconnected from the power supply. Never immerse in water.

The suction hose and the telescopic wand contain electrical wires. The plug connectors must not come in contact with water. These items may only be cleaned with a dry cloth, no moisture must touch them. Danger of electric shock.

This appliance is equipped with a power cord reel. Hold plug when rewinding onto cord reel. Do not allow plug to whip when rewinding.

Do not attempt any repairs other than those listed under Maintenance. Other repairs should be performed by an authorized Miele Service Agent.

The manufacturer can not be held responsible for any work performed by an unauthorized servicer.

Disposal

When disposing of an old appliance, the power cord should be removed. Unplug the vacuum. Cut the power cord off the appliance as close to the vacuum as possible and cut the plug off the cord. The plug cut from the cord should be disabled and thrown away. Under no circumstance should this plug be inserted into a socket (electric shock hazard.)

SAVE THESE INSTRUCTIONS

Preparing for use

- Open the dust chamber seal (depending on model).

The dust chamber seal prevents dust and odors from escaping. If you remove the suction hose from the vacuum cleaner for storage purposes, close the dust chamber seal before putting it away.

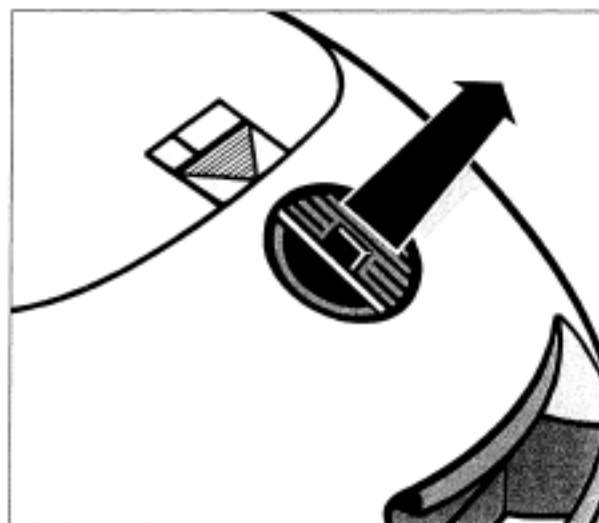

- Insert the elbow, ②, into the suction socket.

Please note:

On models equipped with an SES 110 or SES 115 electric hose, remove the dust cap, ①, from the electric hose connection before inserting the elbow, ②, into the vacuum opening. The SES 110 and SES 115 can be identified by the three prong connector located on the underside of the hose elbow, between the pushbutton locks.



To remove the suction hose from the vacuum cleaner:

- Press the pushbutton locks at the side of the elbow and lift the hose from the socket.



Preparing for use

Connecting the suction hose and the suction wand

- Fit hand-piece of suction hose firmly together with the suction wand.
- To release the hand piece from the suction wand, press the locking button (see arrow).

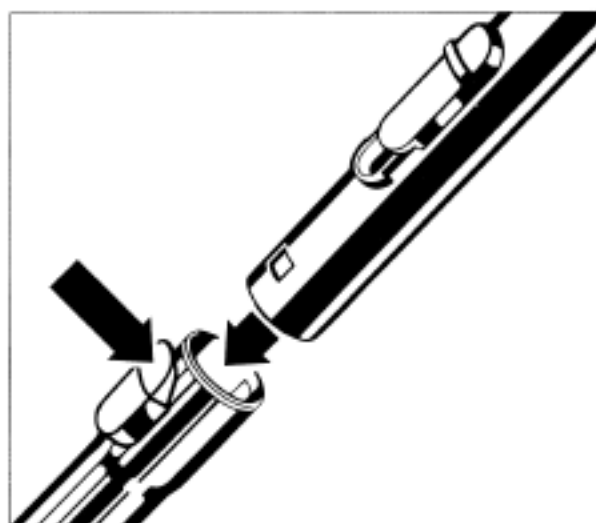

Adjusting the telescopic suction wand

(Depending on model)

One part of the telescopic wand is stored inside the other and can be adjusted to suit your height for comfortable vacuum cleaning.

- Press the slide control (see arrow) to release the lock. Pull apart the sections and adjust to the required height.

Note: When a resistance is felt it has reached its maximum length. Do not force it beyond this length!

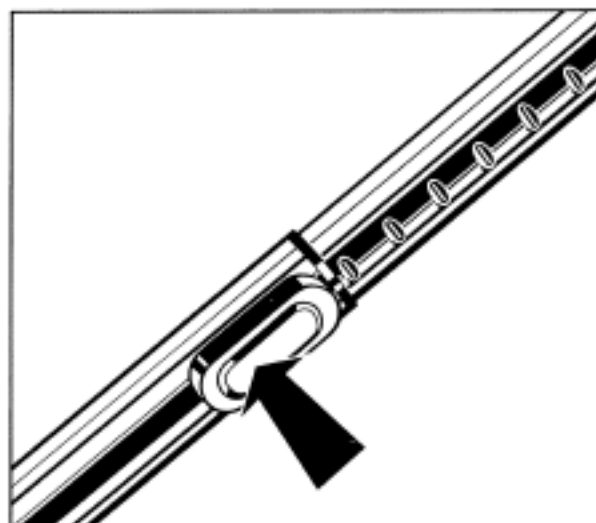

Connecting the suction wand sections

(Depending on model)

Both sections of the suction wand have locating arrows.

- When connecting the two sections, ensure that the two arrows point towards each other.



Attaching the floorbrush

(depending on model)



- Slide the wand into the floorbrush. It must engage securely.
- To release the floorbrush from the suction wand, press the locking button (see arrow).

The floorbrush should be used for the daily cleaning of carpets, rugs and smooth floors. One roller keeps the floorbrush at the correct height above the floor during vacuuming. Occasional contact with a hard surface will not harm the floorbrush, as the base plate material is scratch resistant.

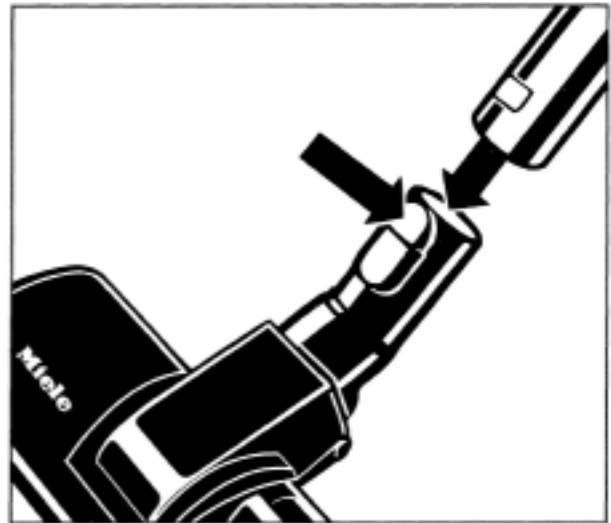
However, for hard floors with a high shine, e.g. parquet (with or without a varnish coating) it is better to use the Miele hard floorbrush or the parquet brush (see 'Optional accessories').



The floor nozzle can be adjusted to conform to the type of flooring to be cleaned.

- To clean hard floors, depress symbol . The brush is now protruding.
- To clean rugs and carpeting, symbol  should be depressed. This retracts the brush.

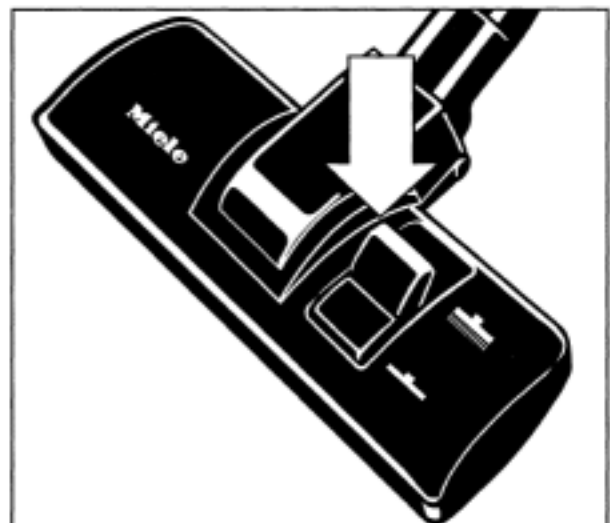

Preparing for use

Hard floorbrush

(depending on model)

Special brush for cleaning hard floors (parquet, ceramic, stone, vinyl).



Using the Powerbrush

Some models come standard with a Powerbrush and Electric hose. Use and Care instructions for these items can be found in the Powerbrush Operating Instructions included with the appliance.



Turbobrush STB 205

(depending on model)

Recommended for cleaning and restoring crushed pile on low nap rugs or carpeting.

The turbobrush is mechanically driven by the suction power of the vacuum cleaner. No electrical connection or electric hose is required for its operation.



Included accessories

Other tools, in addition to the floorbrush, are supplied with the vacuum cleaner to help with various types of cleaning:

From left to right on the illustration:

- **Radiator brush** (depending on model)
- **Crevice nozzle**
- **Dusting brush**
- **Upholstery nozzle**

These tools are stored in the accessory compartment of the vacuum cleaner.



- Press the release button

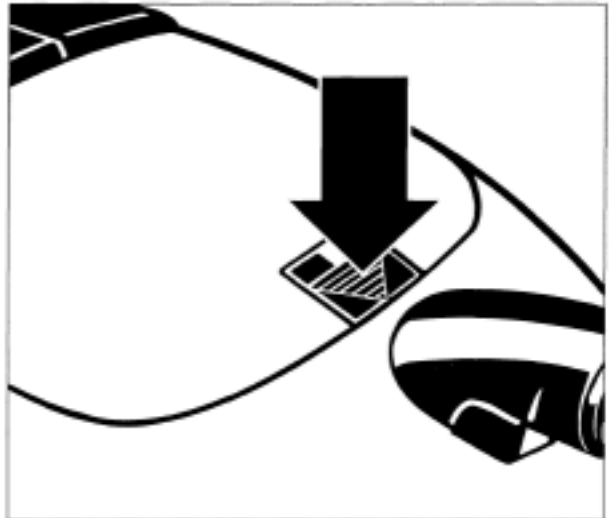

- Open the lid to the accessory compartment. Take out the required tool and close the lid securely.

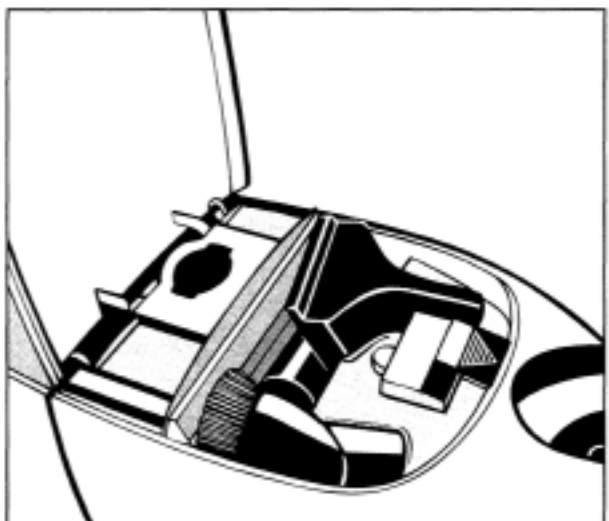

Included accessories

The different tools can be fitted to the hand-piece or to the suction wand.

Radiator brush

(standard or optional, depending on model)

For cleaning radiators, narrow shelves or crevices.

- Fit the radiator brush to the crevice nozzle.



Crevice nozzle

For cleaning in folds, crevices or corners.

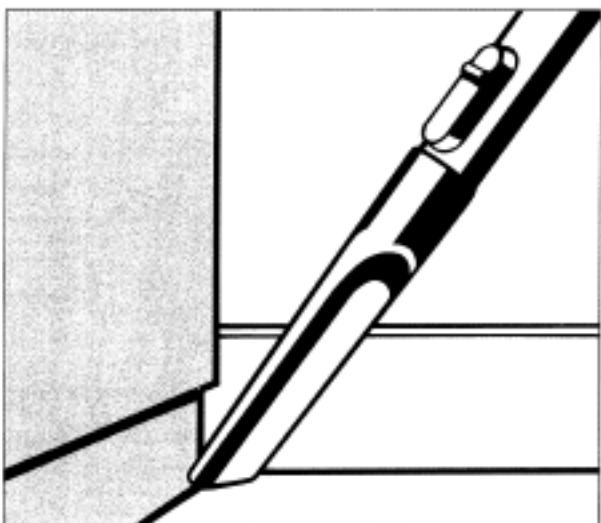

Dusting brush

For cleaning skirting boards, ornate or carved articles, etc.

The head of the dusting brush can be swivelled to attain the best cleaning position.



Upholstery nozzle

For cleaning upholstery, mattresses, cushions, curtains, covers etc.



Blower connection socket

(not available on the S 318i MEDIVAC)

The suction hose can also be connected to the "blower" outlet of the vacuum cleaner. (e. g. for dusting off multi-layered radiators.) It can also be used to "blow out" the suction hose if it should ever become blocked.

For appliances supplied with the SUPER Air Clean filter the blower connection socket is already fitted.

- Open the accessories compartment.
- Insert the elbow of the suction hose into the blower socket.

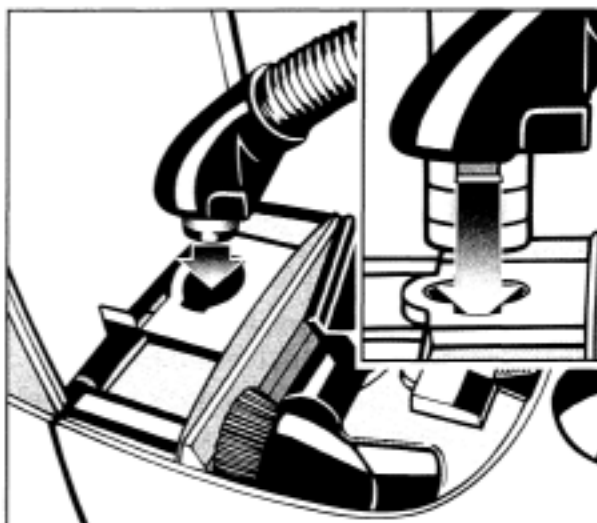

Models equipped with an "ACTIVE air clean filter" are supplied with a blower connection socket as an extra accessory. To be used it must be put in the place of the filter as follows:

- Press the dust compartment lid catch and raise the lid as far as it goes.



Included accessories

- Unsnap the ACTIVE air clean filter catch and remove the filter by first lifting up at the front, and then pulling out.
- Place the blower connection socket at an angle so the rear tabs slip into the notches at the rear of the opening (A).
- Align the socket with the filter, and gently push down on the front until the catch engages and locks it in place (B).
- Close and lock the dust compartment lid.

If the use of an ACTIVE air clean or ACTIVE HEPA filter is desired, the blower connection socket must first be removed. The removal process is identical to that outlined above for the ACTIVE air clean filter. A firm pull will remove the blower socket from its hinge slots.

- Open the accessories compartment.
- Insert the elbow of the suction hose into the blower socket.

Remember to take out the blower connection socket and put the filter back in place when returning to normal suction mode.

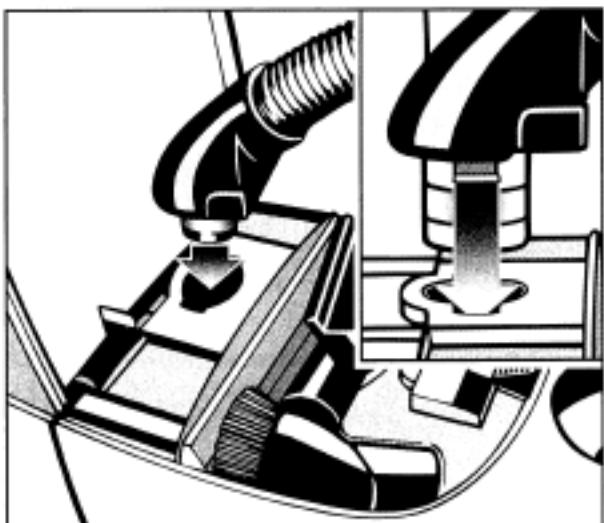
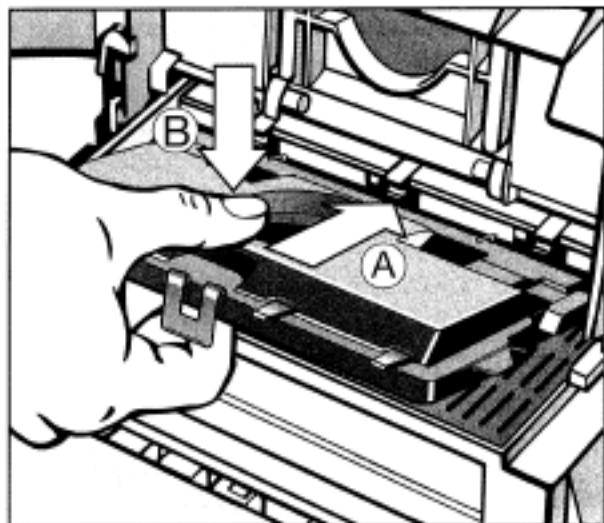
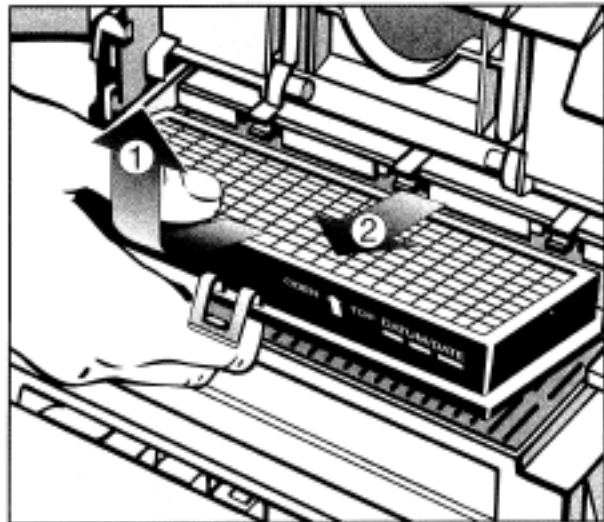

Unwinding and rewinding the power cable

Unwinding

- Pull plug and unwind cable to the required length – max. of 21 ft.

Polarization Instructions

To reduce the risk of electric shock, this appliance has a polarized plug (one blade is wider than the other). This plug will fit in a polarized outlet only one way. If the plug does not fit fully in the outlet, reverse the plug. If it still does not fit, contact a qualified electrician to install the proper outlet. Do not change the plug in any way.

Rewinding

- Press the rewind button and the cable will automatically rewind.

Auto-Reverse

Some models are equipped with "Auto-Reverse". To use this function, move the slide switch to "Auto-Reverse". This releases the cable reel brake and allows the spring-loaded reel to take up the slack between the appliance and the wall socket.

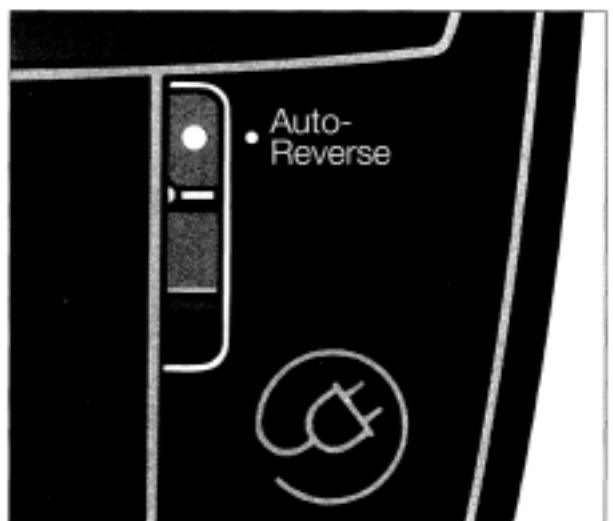

Operation

Switching on and off

To switch the vacuum cleaner on or off:

- Depress the On-Off foot switch.

O = Off

I = On

To prevent static discharge your hand must touch the metal inlay on the underside of the vacuum handpiece. Be certain to continuously touch this inlay when vacuuming fine dust, flour or saw dust as these materials are most likely to create static discharge.



While vacuuming pull the vacuum along by the hose with one hand while continuing to hold the handpiece in the other hand. The vacuum can also be stood on its end for vacuuming stairs, drapes, etc..

Regulating the suction

(only for models with a suction power regulator).

With the suction power selector the setting required for the work at hand can be chosen.

Reducing the suction power reduces the amount of effort required to maneuver the cleaning attachment. By setting the suction to the type of flooring being cleaned, energy will also be saved.

Smooth, lightly soiled flooring is easily cleaned using the Economy  setting. Fitted carpets and thick pile carpets require the most powerful setting to remove ingrained dirt.

The method and type of suction control varies from model to model.

Rotary selector

- Turn the rotary selector to the required suction power setting.

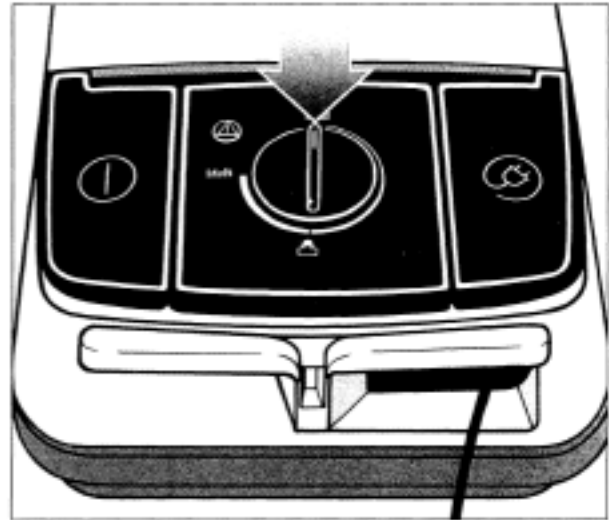

Slide selector

- Move the slide selector to the required suction power setting.

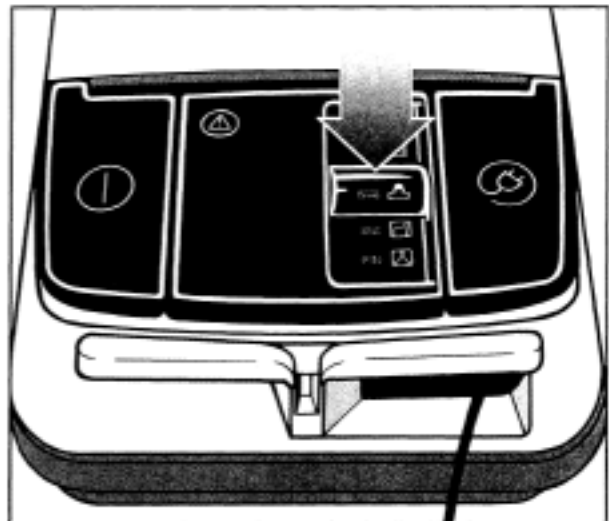

Step selector

- Depress the suction power selector until the required power setting appears in the indicator window.

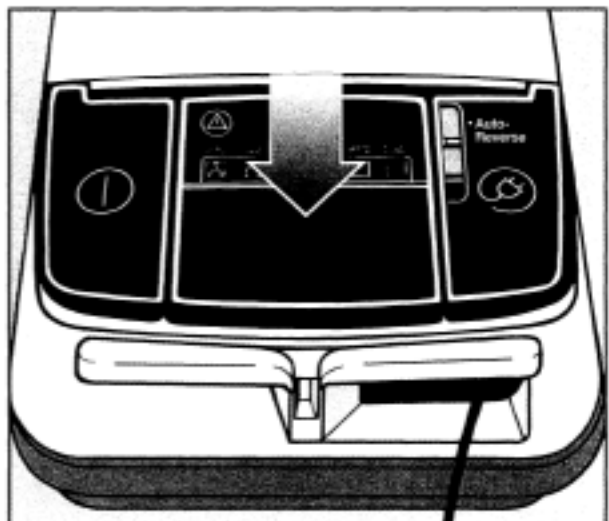

Operation

+/- Switches

- Depress the +/- switch until the desired suction power setting appears in the indicator window.
- Press + for a higher setting.
- Press - for a lower setting.

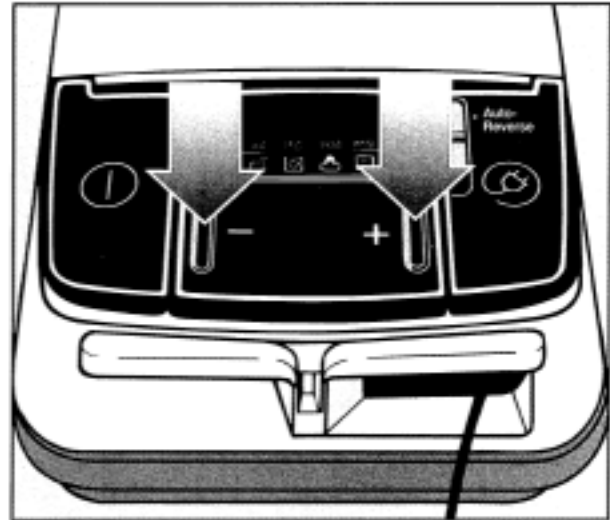

+/- switches with AUTO option

These are used for selecting specific or AUTO suction power settings (Automatic). The chosen setting is displayed by indicator lights.

When turned on, the vacuum cleaner operates at the power setting last used.

- Press the + switch to select a higher suction power setting.
- Press the - switch to select a lower suction power setting.

A single short press of the switch moves the suction power up or down one setting at a time. If the switch is held down the suction power setting will automatically move through the power settings until the switch is released.

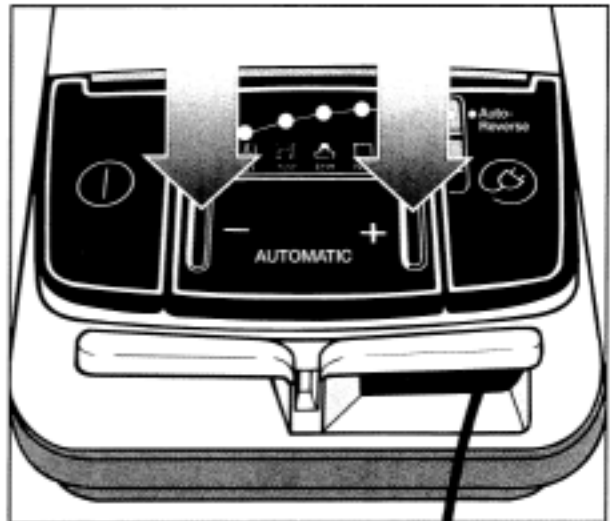

AUTO-Setting (Automatic)

If the AUTO setting is chosen the vacuum cleaner automatically adjusts the suction power to suit the floor type or carpet being cleaned.

- Press the – switch until the AUTO setting is activated.
- Press the + switch to de-activate the AUTO setting.

The AUTO setting is designed for use on carpets and floors only. Do not vacuum light weight articles such as curtains or throw rugs using the AUTO setting. Excessive suction may damage these items.

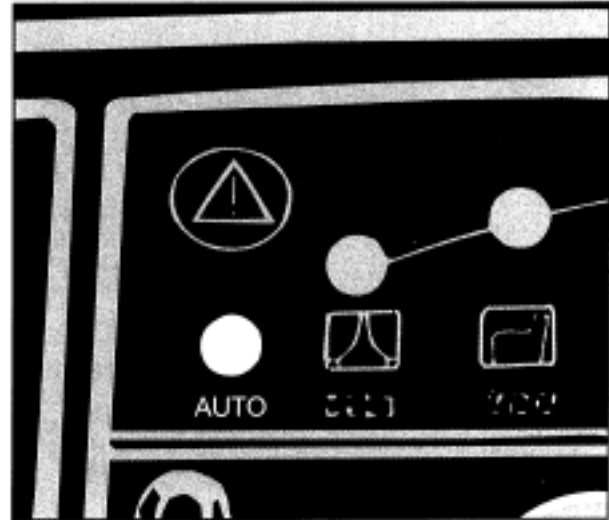

Opening the air inlet valve

The air inlet valve allows quick and easy reduction of the suction power at the floorbrush or attachment when there is a rapid change in the type of surface being cleaned e.g. from carpeted floor to a lightweight rug.

- Open the air inlet valve until the floorbrush or attachment can be easily moved.

Opening the air inlet valve reduces the amount of effort and suction required for maneuvering the cleaning attachment being used.

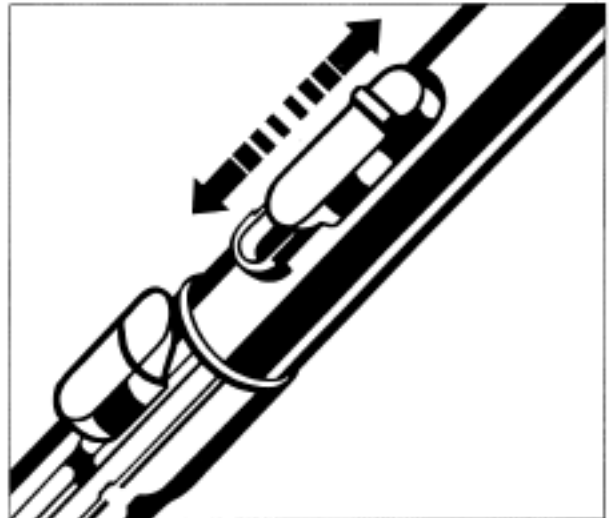

Operation

Park-System

A Park-System has been designed for conveniently parking the vacuum cleaner during pauses. A special parking attachment is fitted to the floorbrush and to the rear of the cleaner.

On selected models, the vacuum will automatically shut off when the floorbrush is parked and resume operation when the floorbrush is removed from the Park-System.

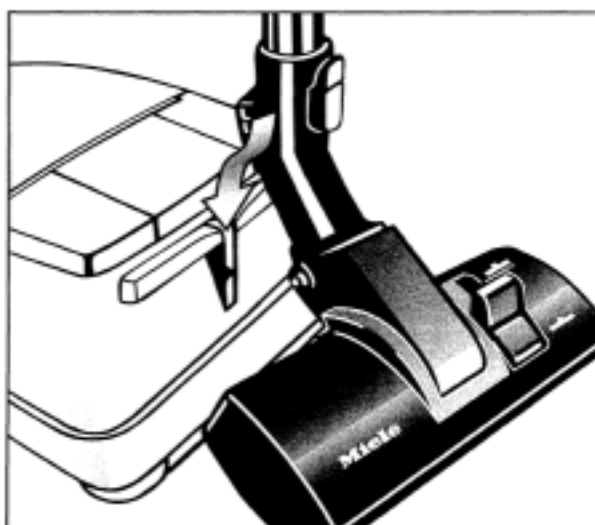

Transportation and storage

- During transportation, when the appliance is not in operation, and during storage:
- Keep the vacuum cleaner vertical.

Clip the floorbrush into the slot on the side of the vacuum cleaner (see illustration).



Suction level indicator

This indicates when the dustbag needs to be changed.

- Set the suction power selector, (according to model), to the highest setting and close the air inlet valve.
- Hold the wand, with the floorbrush attached, off the floor. Turn on the appliance and see whether the red marker completely fills the indicator window. If it does:
- Change the dustbag, even if it is not completely full.

The attachment used can affect the function of the suction level indicator. Therefore, only test with the floorbrush attached.

Please note:

This indicator measures the air permeability of the dustbag. Even if just a few ounces of cement, plaster or brick dust are sucked up, these fine particles can affect the permeability of the dustbag so that the red scale indicates the bag is full, although it is practically empty. The dustbag should be changed in this case, as the suction power is greatly reduced. On the other hand, the bag may be bulging with wool or carpet fluff, but the air permeability may still be high enough not to activate the red scale indicator to maximum. The dustbag should still be changed. Both these extremes can occur.

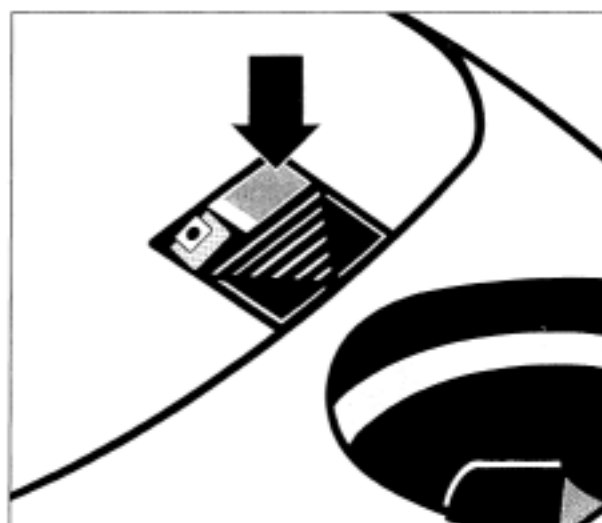

Normally, common household dust is composed of carpet fluff, hair and grit, i.e. a mixture. The Miele dustbag change indicator is designed principally to deal with this kind of use.

May we recommend that:

1. When you vacuum up a lot of fine dust or sand,
 - you change the dustbag as soon as the red scale fills the window, even if the bag is not full.
2. When you have vacuumed up a lot of carpet fluff and hair and the bag is full although the indicator only shows half full,
 - you change the dustbag.

Maintenance and care

Warning!

Do not leave the appliance when plugged in. Turn off and unplug the appliance before opening cover.

The vacuum cleaner is fitted with three filters which must be replaced from time to time in order to guarantee proper efficiency:

- Dustbag (filter bag)
- Exhaust filter (SUPER air clean, ACTIVE air clean, or ACTIVE HEPA filter)
- Dust compartment filter (for motor protection)

Use only genuine Miele dustbags and filters, making sure they are the correct ones for your model. This ensures optimum performance of the suction power and also ensures that the bag is used to capacity.

When should the dustbag and filter be changed?

Changing the dustbag:

When the indicator shows the bag is full, or under the conditions described on page 22.

Changing the exhaust filter:

There are different exhaust filters in different vacuum cleaners:

1. SUPER air clean filter
2. ACTIVE air clean filter
3. ACTIVE HEPA filter

The type of filter in your vacuum cleaner is marked on the filter itself.

SUPER air clean filter:

Each time you start a new packet of Miele dustbags change the filter. A SUPER air clean filter is included with every box of Miele dustbags.

ACTIVE air clean filter:

The ACTIVE air clean filter is a special activated charcoal filter which absorbs odors from the dust collected in the dustbag.

The ACTIVE air clean filter should be changed about every 6 months or when odors are noticeable. If you do not have an ACTIVE air clean filter available, you can use the SUPER air clean filter supplied with every box of Miele dustbags instead. Before inserting it, however, the blower connection socket must be installed (see pages 15/16). There is no difference in filtration levels between the two filters.

HEPA Filter and ACTIVE Air Clean System

The ACTIVE HEPA Filter is a combination Activated Charcoal – HEPA filter in one. In addition to meeting OSHA standards for air filtration, it will also absorb any odors existing in the dust.

Because of its ability to filter out 99.97 % of particles and micro-organisms 0.0003 mm (0.3 microns) or larger in size, vacuum cleaners equipped with this type of exhaust filter are often recommended for allergy sufferers or others with respiratory problems.

The ACTIVE HEPA Filter should be changed at least once a year. The installation date can be written on the edge of the filter. If you do not have an ACTIVE HEPA Filter available, you can use the SUPER Air Clean Filter that comes supplied with every box of Miele paper dustbags instead. Before inserting it, however, the blower connection that was removed when the ACTIVE HEPA Filter was installed must be replaced in the vacuum cleaner (see pages 15/16).

Dust compartment filter:

The dust compartment filter should last a long time and only needs to be changed if it gets very dirty. This may happen if the dustbag is damaged and leaks.

Purchasing new filters and dustbags

Replacement filters and dustbags can be obtained from your local Miele Dealer or direct from the Miele Spare Parts Department.

Order original Miele dustbags with the letter:

- **F/J/M** for models S 300i - S 348i
- **G/N** for models S 400i - S 448i.

Always quote the model number given on the data plate located underneath the appliance.

This ensures optimum performance and increases the lifespan of the machine.

Only use genuine Miele doublelayer dustbags and filters. Technical failures and damage from the use of substitute, inferior dustbags and filters will void any product warranty.

Maintenance and care

To replace the dustbag and filters

Open the dust compartment lid

- With the appliance horizontal, press the lid catch and raise the dust compartment lid until it clicks into place.



Replacing the dustbag

The dustbag has a flap which closes automatically when the dustbag is removed to prevent any dust escaping.

- To remove the dustbag grasp the card collar and pull it out.

It can then be disposed of with the household waste as long as it has only been used for vacuuming up normal household dust.

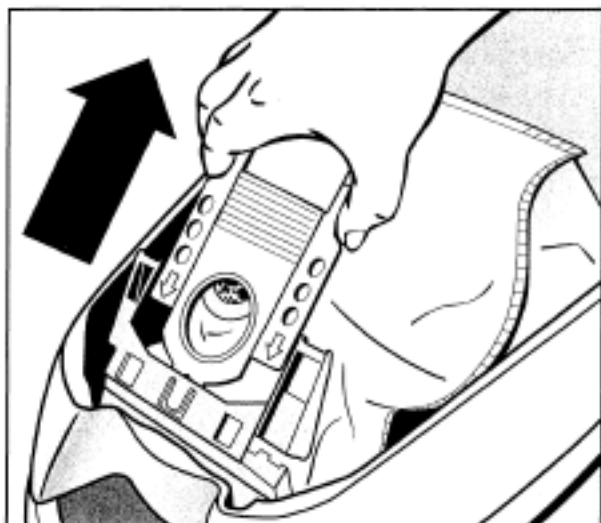

- Place the new dustbag collar securely in the frame. If it is not correctly located the dust compartment lid will not close. Please ensure that the dustbag is not trapped when the lid of the dust compartment is closed.

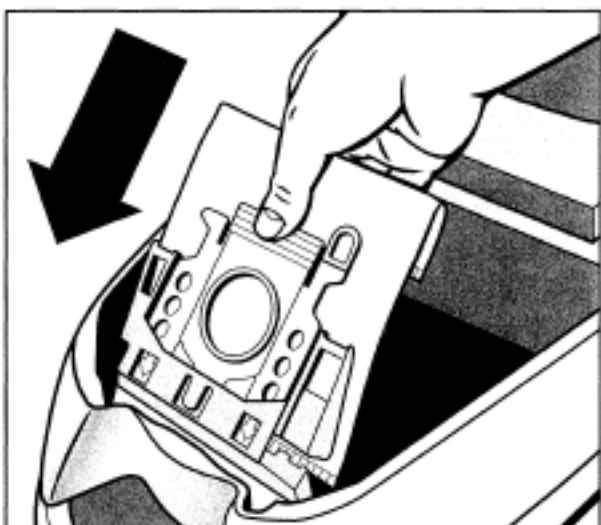

Maintenance and care

Replacing the SUPER air clean filter:

- Release the blower connection socket and raise it upwards.
- Grasp the used SUPER air clean filter by the clean, unsoiled section (see arrow in diagram) and take it out.
- Replace it with a new SUPER air clean filter. It can be inserted either way up.
- Lower and secure the blower connection socket back in place.

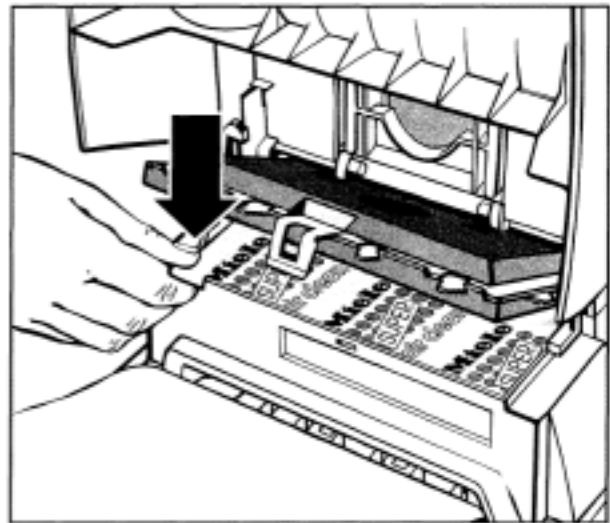

Replacing the ACTIVE air clean filter:

- Open the dust compartment lid.
- Remove the used ACTIVE air clean filter and replace it with a new one.
- Making sure that the printed side faces upwards, insert the filter until you hear a "click", then close and lock the compartment lid.

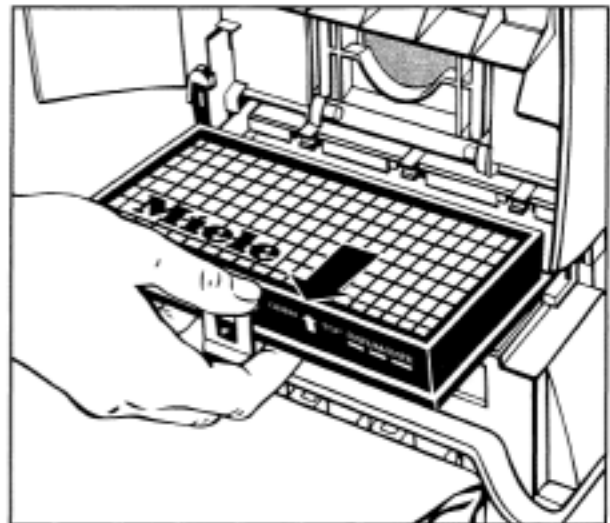

Replacing the ACTIVE HEPA filter:

- Open the dust compartment lid.
- Remove the used ACTIVE HEPA filter and replace it with a new one.
- Making sure that the printed side faces upwards, insert the filter until you hear a "click", then close and lock the compartment lid.

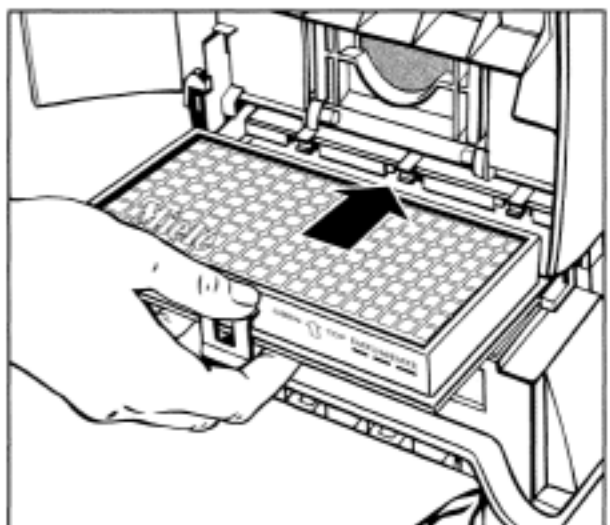

Maintenance and care

Replacing the dust compartment filter:

Models S 300i – S 348i

- Open the dust compartment lid.
- Open the filter door, remove the used filter and replace it with a new one.
- Close the filter door.
- Close the dust compartment lid.

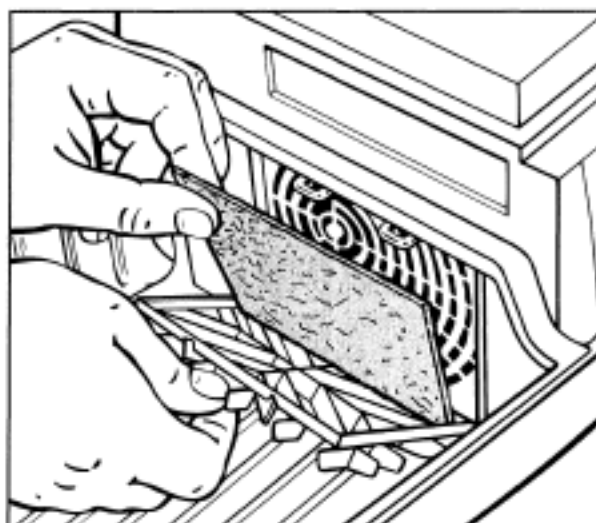

Models S 400i – S 448i

- Open the dust compartment lid.
- Remove the used dust compartment filter and replace it with a new one.

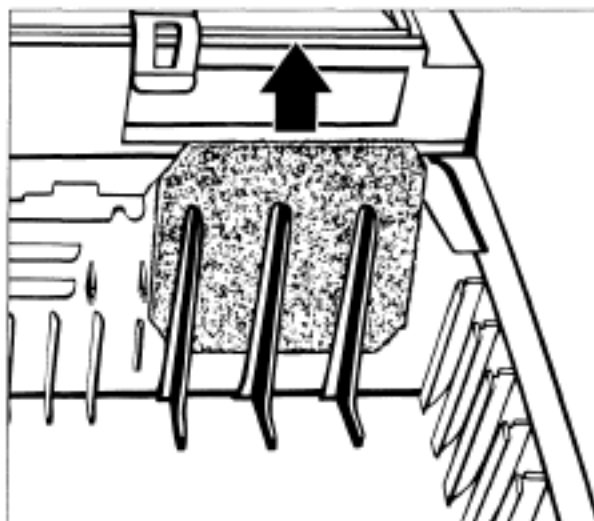

Maintenance and care

Changing the thread catcher pads

Check the thread catchers on the suction inlet of the floor attachment and the upholstery nozzle from time to time. Replace the pads if the pile is worn.

- Use a screwdriver or similar object to remove the thread catcher pads from the slots.
Fit the new thread catcher pads.

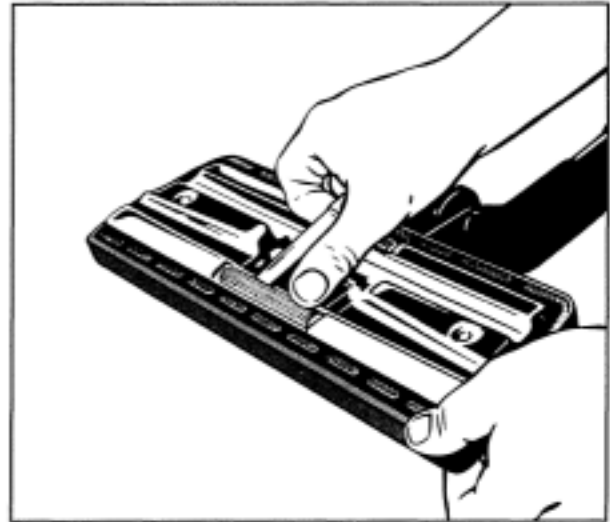

Servicing the floor roller

1. Lift up the axle lever
2. Slide out the axle
3. Lift out the roller

Remove foreign objects; after cleaning replace the roller assembly.

Spare parts are available from your Miele Dealer or the Miele Spare Parts Department.

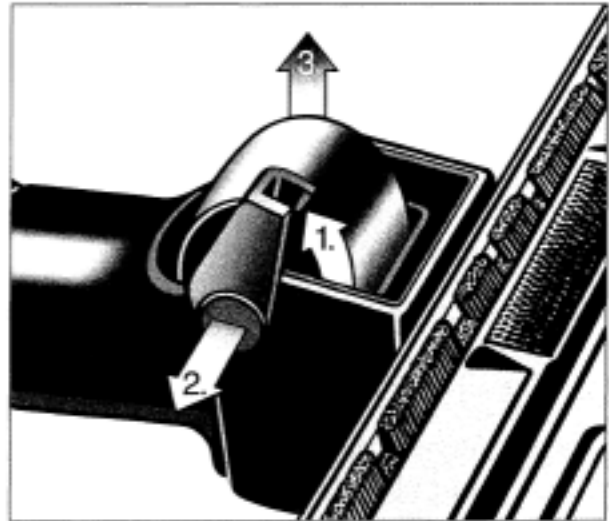

Cleaning and care

Warning!

Do not leave the appliance when plugged in. Turn off and unplug the appliance before opening cover.

Vacuums and Accessories

The vacuum cleaner and other plastic components can be cleaned using a damp cloth or a cleaner made especially for plastics.

Do not use abrasive, glass, or all purpose cleaning solutions as these can cause considerable damage to the plastic components of the vacuum or accessories.

Dust Compartment

The dust compartment can be cleaned using another vacuum, if available, or a dry cloth or brush.

Monitor the change dustbag indicator and inspect all filters regularly. Clean or replace them when necessary according to the Operating Instructions.

Never immerse the vacuum cleaner in water.

If the appliance switches itself off and the overheating indicator light  comes on (some models):

A temperature limiter switches the vacuum cleaner off automatically if it gets too hot. With some models there is a warning light  which comes on to indicate "Warning – Overheating".

This can occur if, for instance, large articles block the suction tube or when the dustbag is full.

A heavily soiled exhaust or dust compartment filter can also be the cause of overheating.

In this case, please switch off the vacuum cleaner. (Press the On-Off switch).

After removing the cause of overheating wait for approx. 20 - 30 minutes, so that the appliance can cool down. It can then be switched on again.

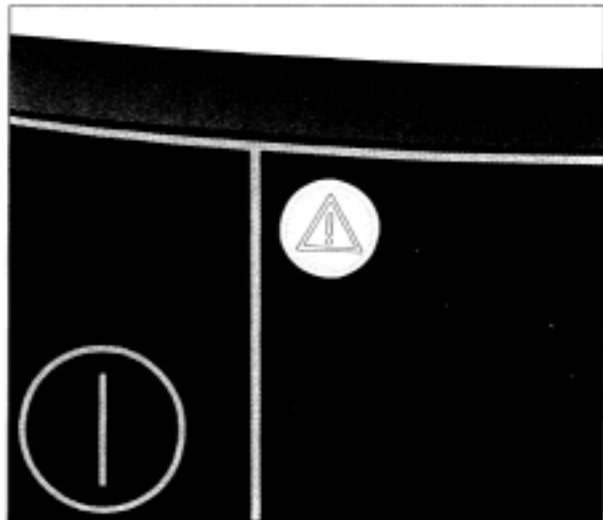

Electrical connection

- Connect the vacuum cleaner only to a 120 V/60 Hz, 15 A fused outlet.

Optional accessories

Turbobrush STB 205

(Standard or optional, depending on model)

Recommended for cleaning and restoring crushed pile on low nap rugs or carpeting.

The turbobrush is mechanically driven by the suction power of the vacuum cleaner. No electrical connection or electric hose is required for its operation.



Hand Turbobrush STB 101

The hand Turbobrush is intended for vacuuming upholstery, mattresses, car seats, carpeted stairs and other areas inaccessible to the standard Turbobrush.

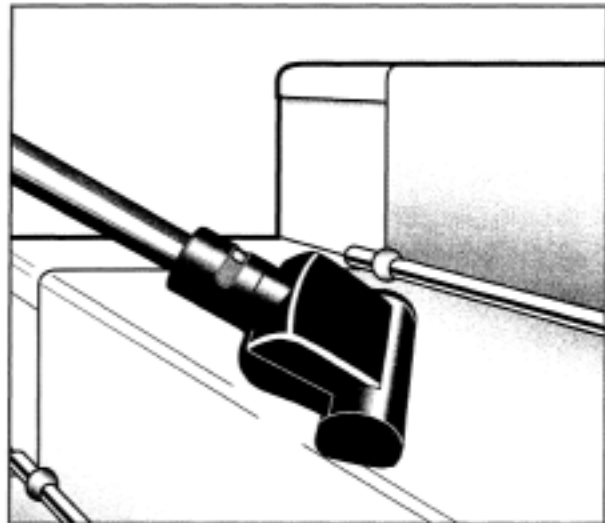

Mattress brush

(standard on some models)

For vacuuming mattresses and upholstery. Even deep crevices between mattresses can be vacuumed conveniently.

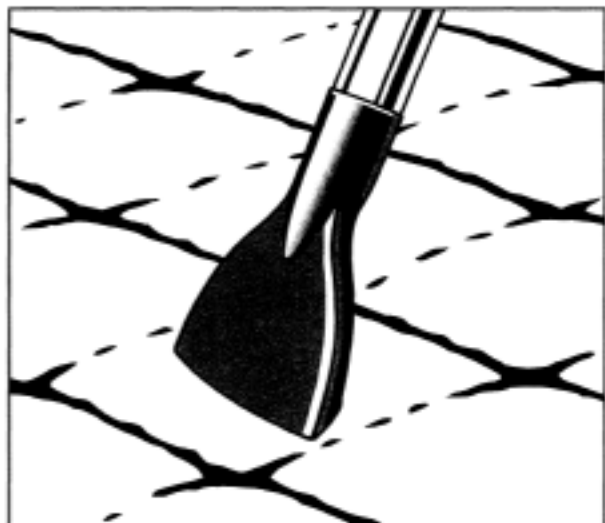

Optional accessories

SEB 213 Powerbrush

(Standard or optional, depending on model)

Recommended for cleaning and restoring of crushed carpet pile on medium-nap carpeting.

With a deeper cleaning action than the turbobrush, the SEB 213 is electrically driven.

Brush width – 10½" (26.5 cm)

To operate the powerbrush, the SES 105 or SES 110 (included with certain models) electric hose is required.



SEB 226 Powerbrush

Recommended for cleaning and restoring of crushed carpet pile on highnap carpeting.

Electrically driven, the SEB 226 has a height adjustment feature for different nap heights.

Brush width – 13⅜" (34 cm)

To operate the powerbrush, the SES 115 electric hose and the SET 210 electric wand are required.



Radiator brush

For cleaning radiators, narrow shelves or crevices.

- Fit the radiator brush to the crevice nozzle.



Optional accessories

Hard floorbrush

(standard or optional accessory depending on model)

For cleaning smooth floors (e.g. stone, PVC).



Parquet brush

Special brush with genuine horsehair bristles for cleaning parquet floors, floorboards and flooring which is susceptible to scratching.



Universal brush

For dusting books, shelves, etc.



Optional accessories

ACTIVE air clean filter

(standard on some models)

This is a special activated charcoal filter which absorbs odors from the dust. The ACTIVE air clean filter is used in place of the SUPER air clean filter. The blower connection socket must be taken out of the appliance if the ACTIVE air clean filter is used. There is no difference in filtration level between the ACTIVE air clean filter and the SUPER air clean filter.

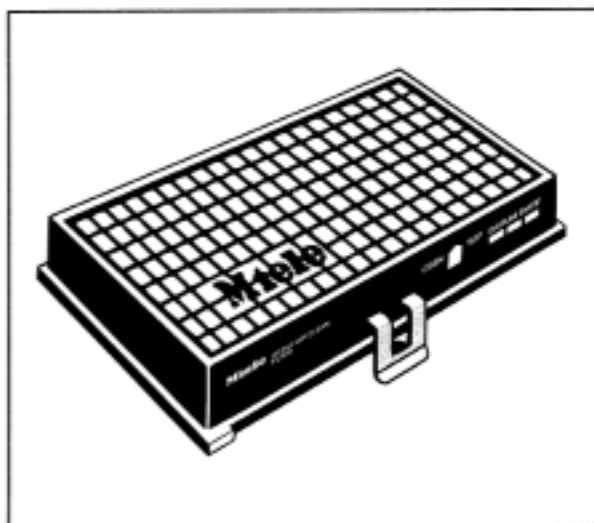

ACTIVE HEPA filter

(standard on some models)

The ACTIVE HEPA Filter is a combination Activated Charcoal – HEPA filter in one. In addition to meeting OSHA standards for air filtration, it will also absorb any odors existing in the dust. Because of its ability to filter out 99.97 % of particles and micro-organisms 0.0003 mm (0.3 microns) or larger in size, vacuum cleaners equipped with this type of exhaust filter are often recommended for allergy sufferers or others with respiratory problems.

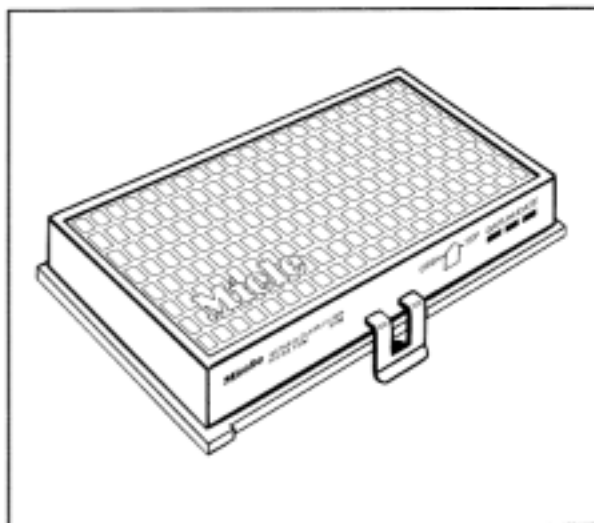

Dusting brush with horsehair

For dusting particularly delicate objects.



Optional accessories

MicroSet

This set is specially designed for cleaning intricate small objects and difficult to reach areas (such as PC keyboards, stereo equipment, intricately carved furniture and ornaments, models etc).

Accessory set consisting of:

- micro hose with combi nozzle (crevice nozzle and dusting brush)
- micro dusting brush
- micro crevice nozzle and
- angled extension

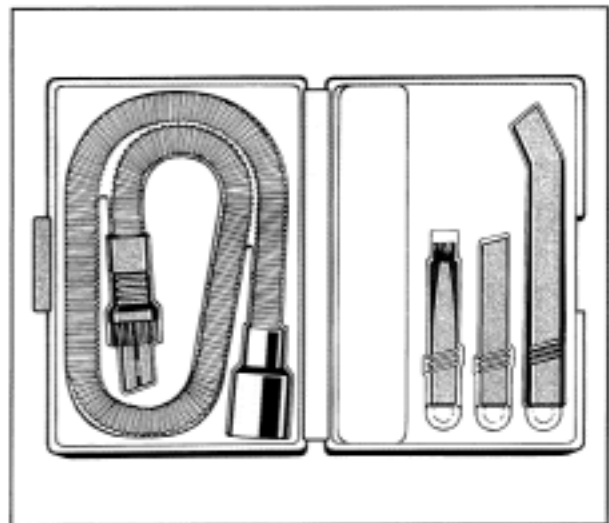

CarClean Set Plus

Specially designed for cleaning car interiors.

The accessory kit includes:

- the Miele TurboMini
- micro hose with Combi nozzle
- crevice nozzle (300 mm)
- accessory carrying case
- a 10 foot long (3 m) suction hose with holder

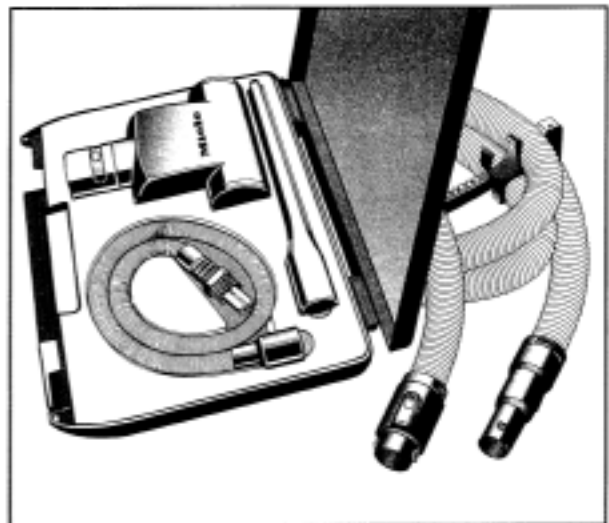

Crevice nozzle, 300 mm

For cleaning in folds, crevices or cornes.

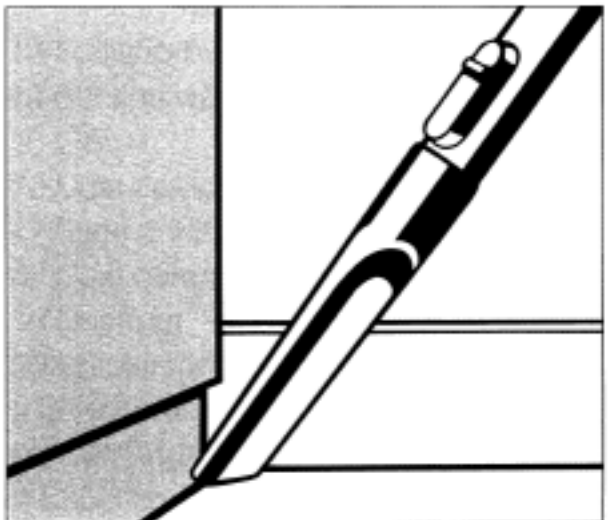



Miele, Inc. (USA)

National Headquarters

9 Independence Way
Princeton, NJ 08540
Phone: 800-843-7231
609-419-9898
Fax: 609-419-4298
www.mieleusa.com

Technical Service & Support

Nationwide

Phone: 800-999-1360
Fax: 888-586-8056

Mid-West Region

Phone: 800-666-6740
Fax: 847-714-9434

South-East Region

Phone: 561-995-8030
Fax: 561-995-8083

West-Coast Region

Phone: 800-245-8215
Fax: 415-241-6822

Miele Limited (CDN)

National Headquarters

55G East Beaver Creek Road
Richmond Hill, ON L4B 1E5
Phone: 800-565-6435
905-707-1171
Fax: 905-707-0177
www.miele.ca
info@miele.ca (general enquiries)
service@miele.ca (tech. service)

Technical Service & Support

Ontario Region

Phone: 905-707-1171
Fax: 905-707-0177

Quebec Region

Phone: 877-636-4353
Fax: 514-277-1838

British Columbia Region

Phone: 604-434-1300
Fax: 604-434-1309