

# Miele®

## Operating Instructions for the Vacuum Cleaner



CARING FOR  
THE ENVIRONMENT

This paper is manufactured from straw cellulose. Straw is a natural agricultural residue from cereal production and its use in paper helps to save more trees.

USA

T.-Nr. 2649872/04

# IMPORTANT SAFETY INSTRUCTIONS

When using an electrical appliance, basic precautions should always be followed, including the following:

## READ ALL INSTRUCTIONS BEFORE USING THIS APPLIANCE

### WARNING -

To reduce the risk of fire, electric shock, or injury:

- Check the voltage rating of the vacuum cleaner before connecting the power cord to an electrical outlet. Your power source should correspond with the voltage rating given on the rating plate located on the underside of the vacuum cleaner. Use only household AC outlets. Never use DC power sources. If you are unsure of the voltage supply in your area, consult a qualified electrician. Connection of the vacuum cleaner to a higher voltage than indicated in these instructions may result in damage to the vacuum cleaner and personal injury.
- Do not leave the appliance when plugged in. Unplug from the outlet when not in use and before servicing.
- Do not use outdoors or on wet surfaces.
- Do not allow the vacuum cleaner to be used as a toy. Close attention is necessary when used by or near children.
- Use only as described in this manual. Use only manufacturer's recommended attachments.
- Do not use with damaged cord or plug. If the appliance is not working as it should, has been dropped, damaged, left outdoors, or immersed in water, return it to a service center.
- Do not pull or carry by the cord, use the cord as a handle, close a door on the cord, or pull the cord around sharp edges or corners. Do not run the appliance over the cord. Keep the cord away from heated surfaces.
- Do not unplug by pulling the cord. To unplug, grasp the plug, not the cord.
- Do not handle the plug or appliance with wet hands.
- Do not put any objects into the openings. Do not use with any opening blocked; keep free of dust, lint, hair, and anything that may reduce air flow.
- Keep hair, loose clothing, fingers, and all parts of the body away from openings and moving parts.
- Do not pick up anything that is burning or smoking, such as cigarettes, matches, or hot ashes.
- Do not use without the dustbag and/or filters in place.
- Turn off all controls before unplugging.

- Use extra care when cleaning on stairs.
- Do not use to pick up flammable or combustible liquids, such as gasoline, or use in areas where they may be present.
- When using this appliance in conjunction with an electrobrush and a current-carrying hose:
  - The hose contains electrical wires. Do not use if damaged, cut, or punctured. Avoid picking up sharp objects.
  - Always turn off this appliance before connecting or disconnecting either the hose or the electrobrush.
- This appliance is equipped with a power cord reel:
  - Hold the plug when rewinding onto the cord reel. Do not allow the plug to whip when rewinding.
- When using this appliance in conjunction with the Turbobrush:
  - Always unplug before connecting.
- Use only attachments specified by the manufacturer. Do not use the blower to operate paint sprayers or similar devices that emit volatile or toxic vapors.
- The vacuum cleaner shuts off automatically by thermostatic control if it overheats. Overheating could be due to a clogged hose, a heavily soiled dust compartment or exhaust filter, or a full dustbag. If this occurs, rectify the problem and wait about 15 minutes for the motor to cool down. The vacuum cleaner can then be switched on again.
- Do not switch on or attempt to operate the vacuum cleaner unless a dustbag and dust compartment and exhaust filters are in place. Use only genuine MIELE double-layer dustbags and filters (see 'Maintenance' for instructions on how to insert the dustbag and filters). If no dustbag has been inserted, the dust compartment cover cannot be closed.

**DO NOT USE FORCE!**

## **SAVE THESE INSTRUCTIONS**

**THIS APPLIANCE IS INTENDED STRICTLY FOR HOUSEHOLD USE ONLY**

## **WARNING:**

Electric shock could occur if the vacuum cleaner is used outdoors or on wet surfaces.

- Always switch off the vacuum cleaner and disconnect the plug from the wall outlet before servicing (see 'Maintenance'). Do not attempt any other repairs. Other servicing should be performed by an authorized Service Agent.
- Protect your vacuum cleaner from heat and moisture. Store in a cool, dry place, away from children and household traffic.

# Description of the appliance

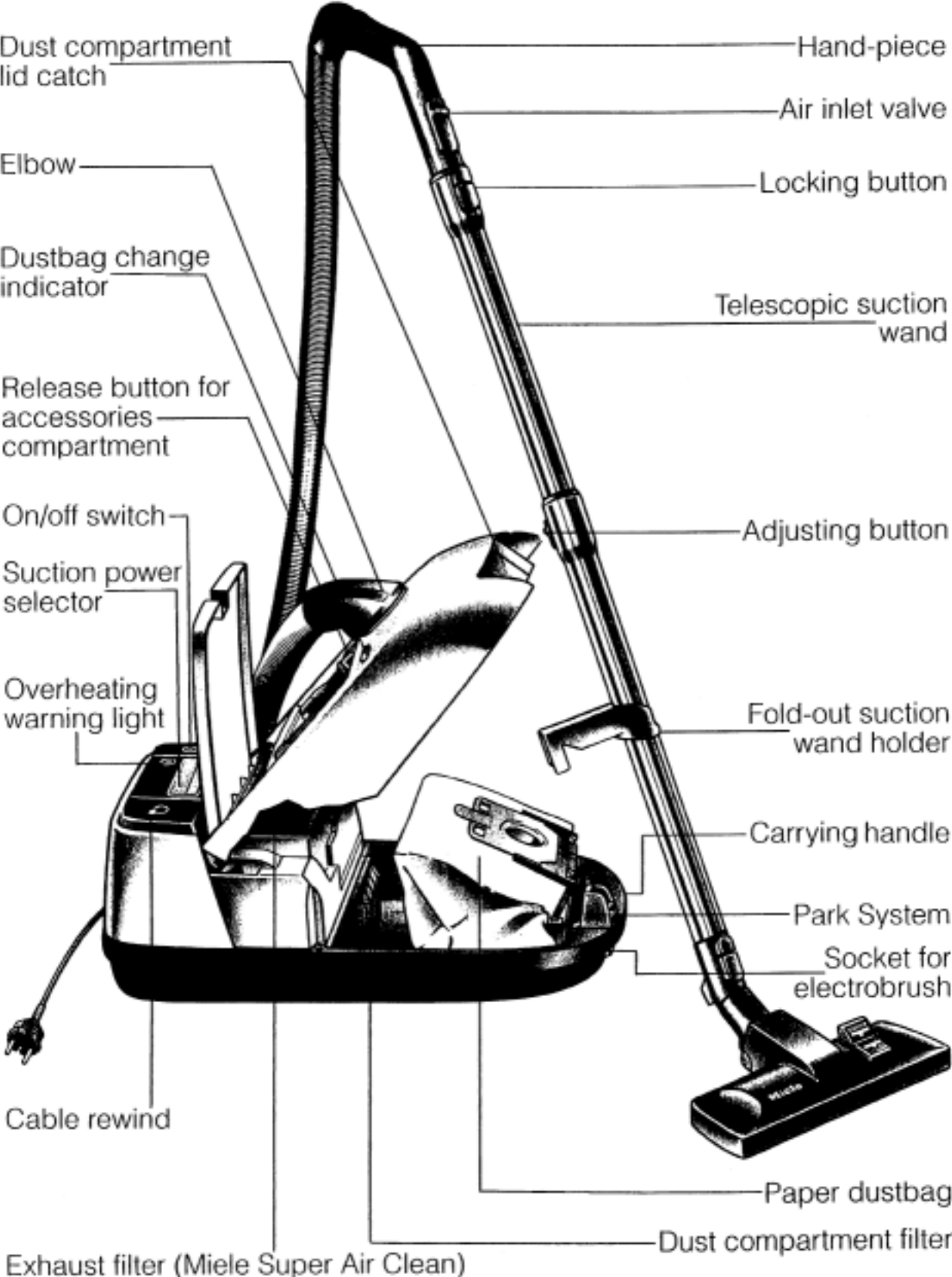

# Assembling the vacuum cleaner

---

## **Connecting the suction hose to the vacuum cleaner**

- Insert the elbow hose coupler into the suction opening, as shown, until it snaps into position.
- To disconnect the hose from the vacuum cleaner, press the locking buttons on the elbow and lift out of the suction opening.

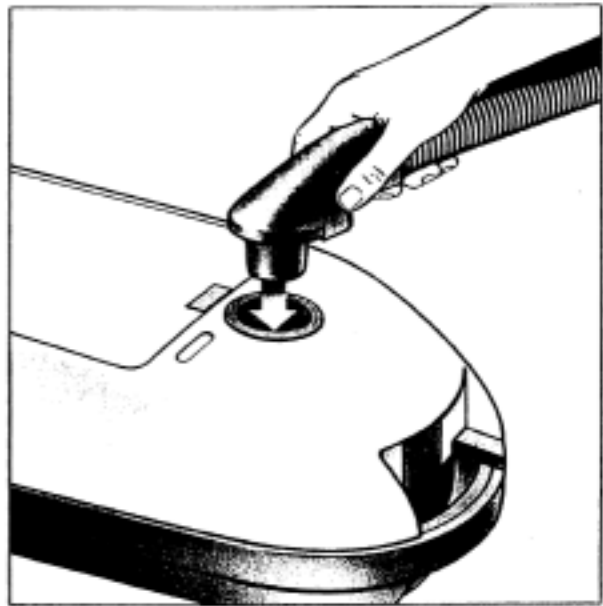

## **Connecting the telescopic suction wand to the suction hose**

- Fit the hand-piece of the suction hose firmly together with the suction wand.
- To release the hand-piece from the suction wand, press the locking button (see arrow).

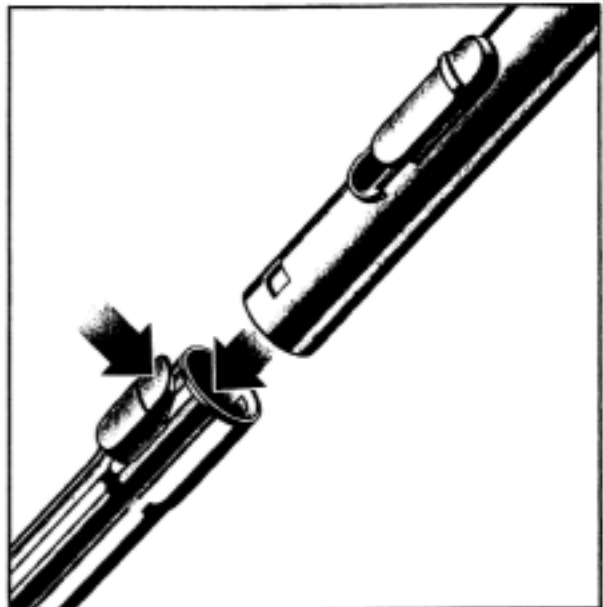

# Assembling the vacuum cleaner

---

## **Adjusting the telescopic wand**

The telescopic wand has two interconnected parts that can be adjusted to suit your height for convenient vacuum cleaning.

### **To adjust:**

- Bring the adjuster control upwards, or press downwards and adjust the suction tubes to the required length.

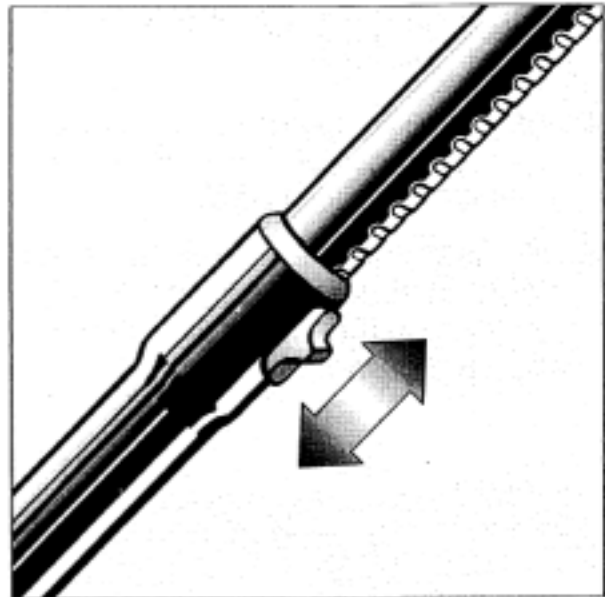

## **Attaching the telescopic wand holder**

- Attach the retractable wand holder to the telescopic suction wand and fold down.

In the unfolded position, the wand complete with suction hose and floor nozzle may be inserted into the receptacle on the carrying handle for convenient transportation and storage (see P. 17).

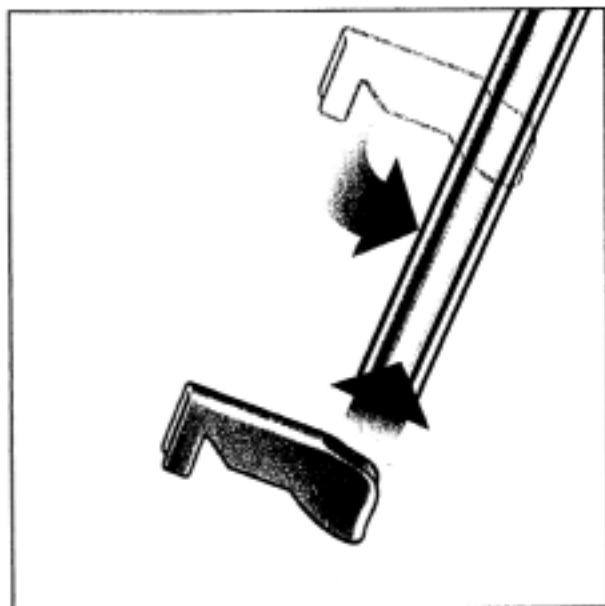



# Assembling the vacuum cleaner

---

## Attaching the floor nozzle

The **floor nozzle** is recommended for routine cleaning of rugs, carpeting and hard flooring such as parquet, tile, linoleum or stone.

- Fit the telescopic suction wand onto the floor nozzle, as shown by the arrow. The floor nozzle must lock into place securely.
- To release the floor nozzle from the suction wand, press the locking button.
- The floor nozzle can be adjusted to conform to the type of flooring to be cleaned.
- To clean hard floors, depress symbol . The brush is now protruding.
- To clean rugs and carpeting, symbol  should be depressed. This retracts the brush.

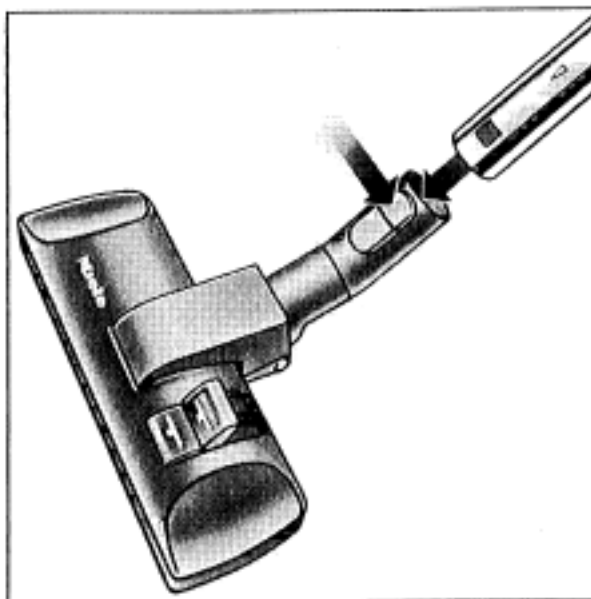

## Standard accessories

---

Two other nozzles in addition to the floor nozzle are supplied with the vacuum cleaner to comply with various suction requirements:

- crevice nozzle
- upholstery nozzle

These accessories are stored in a special compartment of the vacuum cleaner.

- Press the locking button.



- Open the lid.

These different nozzles can either be fitted to the hand-piece or, if necessary, to the telescopic suction wand.

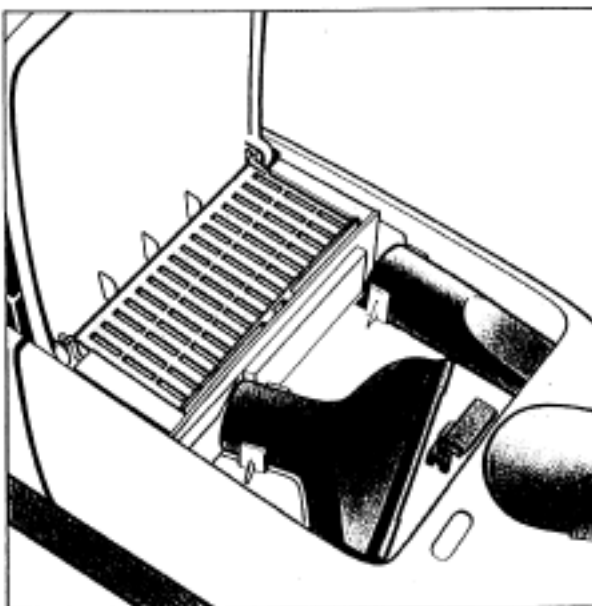



## Standard accessories

---

### **Crevice nozzle**

For cleaning folds, crevices and corners.

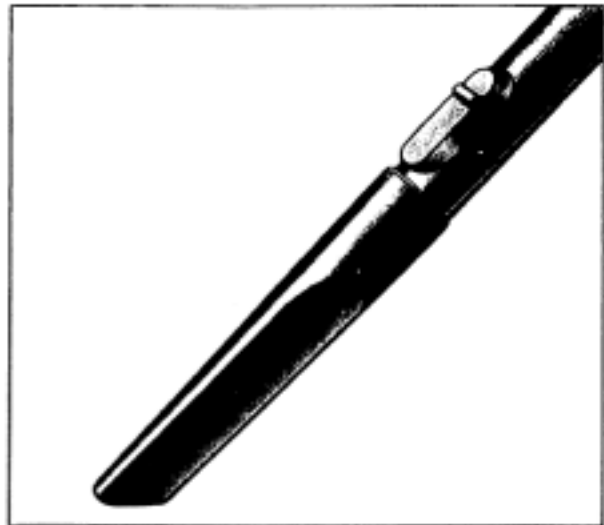

### **Upholstery nozzle**

For cleaning upholstery, mattresses, cushions, curtains, clothing, etc.

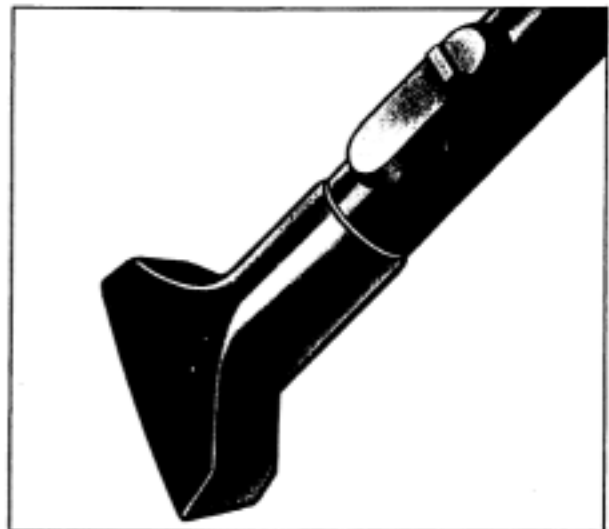

## Optional extras

---

### **Dusting brush**

For cleaning skirting boards, ornate or carved articles, etc.

The head of the dusting brush can be swivelled to attain the best cleaning position.



### **Radiator brush**

For cleaning radiators, narrow shelves or crevices.

- Fit the radiator brush onto the crevice nozzle.



### **Universal brush**

For dusting books, shelves, etc.



### **Turbobrush**

For gentle brushing and cleaning of short-pile high-quality carpeting.

The Turbobrush is fitted to the suction wand and is operated by the suction power of the vacuum cleaner.



### **Floor brush**

Special brush for cleaning hard flooring (parquet, stone, linoleum).

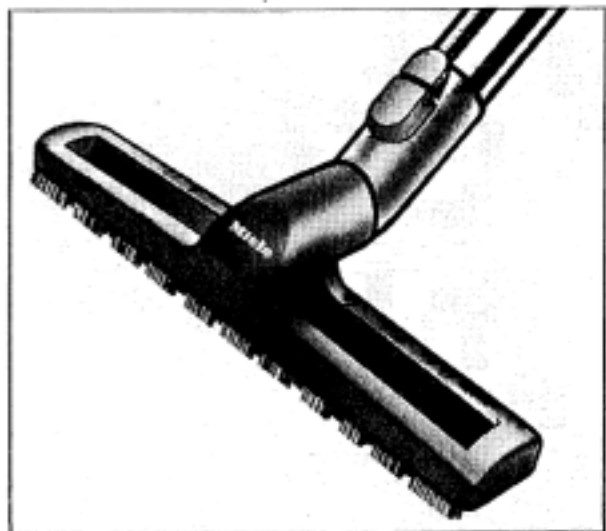

### **Cloth dustbag**

The cloth bag is easily emptied and shaken out by removing the pinch-bar.

**Do not wash the dustbag as this will restrict the air flow capacity of the bag.**

All dustbags are available from your dealer.

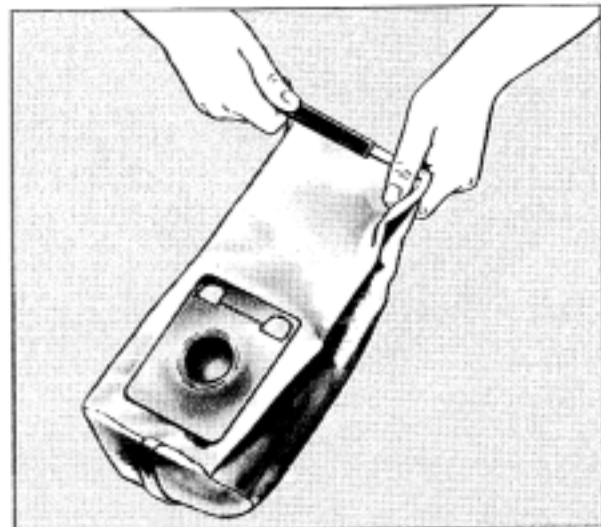

## Optional extras

---

### **Electrobrush SEB 245**

This electrobrush consists of

- the electrobrush unit with connection lead and plastic clamps to attach it to the suction wand.
- the electro suction hose with plug and socket.

The plug is connected via the appliance socket on the cleaner.

The electrobrush lead cable is connected via the socket in the hand-piece of the electro suction hose.

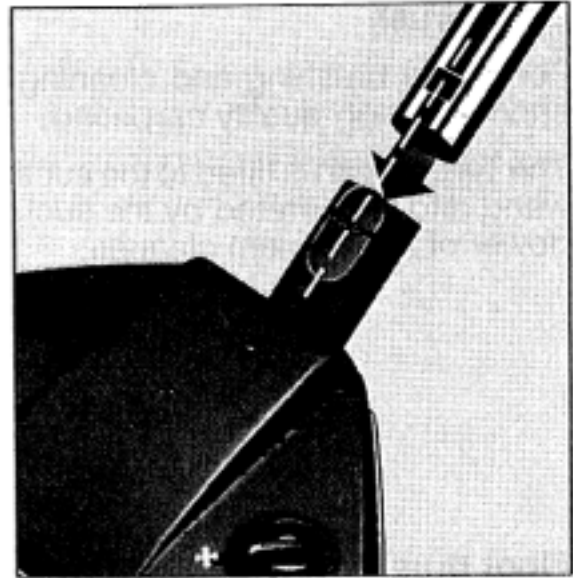

## Unwinding and rewinding the cable

### **Unwinding**

- Hold the plug and unwind the cable to the required length (max. 21 ft.)



### **Rewinding**

- Press the rewind button; the cable will rewind automatically.

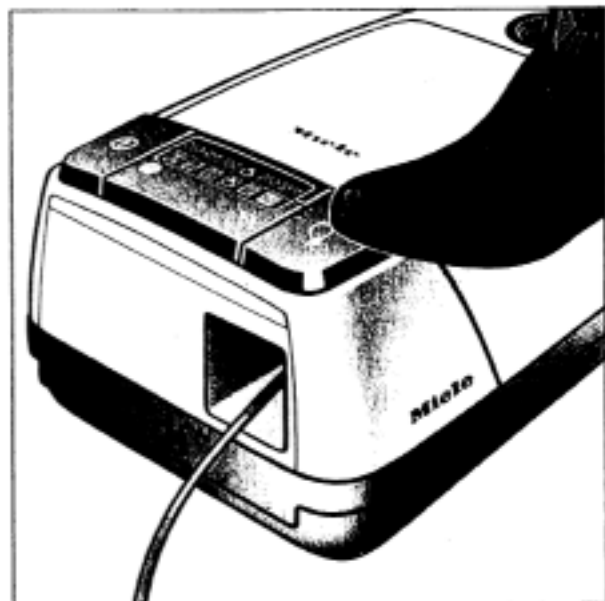

# Operation

---

## **Switching the vacuum cleaner on and off**

To switch the vacuum cleaner on or off:

- Depress the foot switch

When in operation, the vacuum cleaner can be moved on its rollers or stood on end, when stairs or curtains are being cleaned.

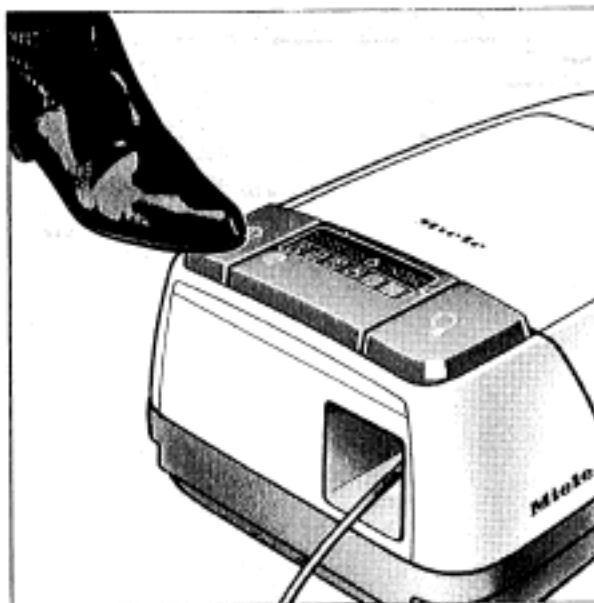

## **Selecting suction power**







The vacuum cleaner is equipped with an electrical suction power selector.

Depending on the situation, six settings are available to choose from:

Reducing the suction power reduces the amount of effort required for manoeuvring the cleaning attachment. By setting the suction regulator according to the degree of soiling and type of flooring being cleaned energy will also be saved.

Energy is saved when the appropriate suction setting is selected for the job at hand. See symbols on the suction power selector.



-  = Drapes, textiles
-  = Upholstery, cushions
-  = Quality carpets, rugs and runners
-  = Economy setting for daily use
-  = Textured and fitted carpets
-  = Hard floor covering; for intensive cleaning of carpeting

## **Suction regulator (Air inlet valve)**

For quick and easy reduction of suction power, as needed when cleaning curtains, drapes and light-weight area rugs:

- To avoid rugs, drapes, etc., from getting sucked up.
- Only open the air inlet valve until the suction nozzle can be easily moved.

Opening the air inlet valve reduces the amount of effort and suction required for manoeuvring the cleaning attachment being used.

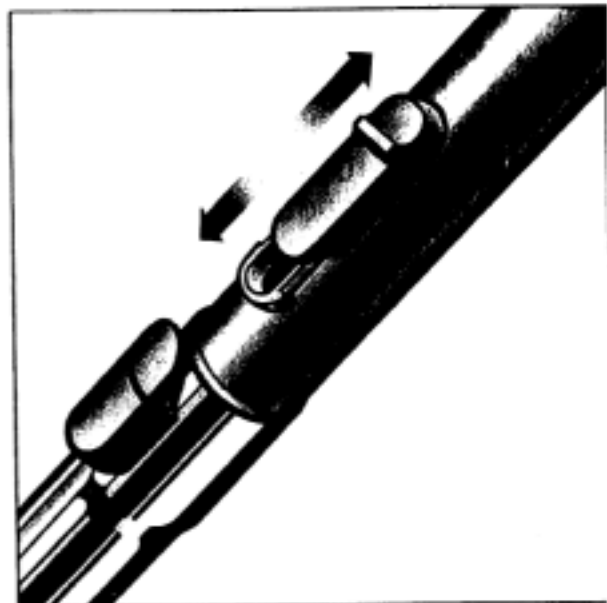

# Operation

---

## **Dustbag change indicator**

This indicates when the dustbag needs changing.

- Set the suction power selector to maximum.  
Switch on the vacuum cleaner and lift up the floor nozzle so that it is not resting on the floor. If the red mark on the dustbag change indicator covers the window completely, change the dustbag, even if it does not seem completely full.

### **Please note:**

The dustbag change indicator reacts to the porosity of the dustbag. On the one hand, a small amount of cement, plaster or fine dust is enough to indicate a full bag, although the latter is almost empty. On the other hand, the bag can be full of carpet fluff and threads, although the indicator scarcely reacts. Such extremes seldom occur, as household dust is usually a mixture of carpet lint, hair and sand. The MIELE dustbag change indicator is designed to react to such mixtures of dust.

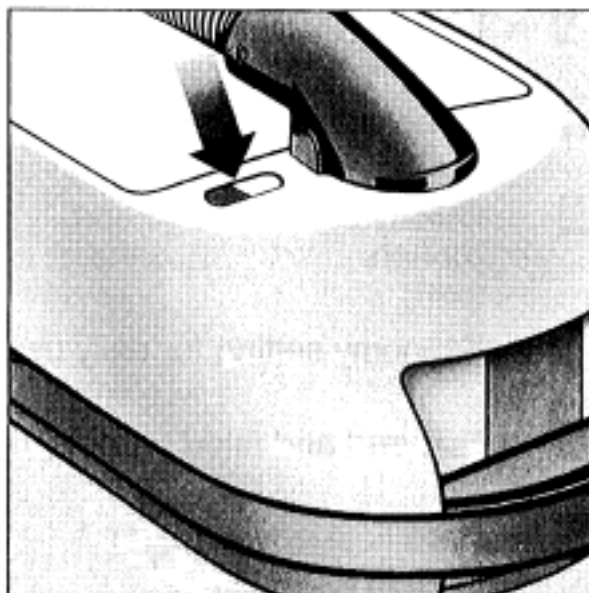

### **We recommend the following:**

1. When vacuuming a lot of sand and dust:  
Change the dustbag, if the indicator shows "full".
2. When picking up a lot of lint and hair, the indicator will show the dustbag as only "half full", when it is actually bulging.

**Important:** Nozzles, such as the crevice nozzle, affect the function of the dustbag change indicator. Therefore, only attach the **floor nozzle** when checking whether the bag is full.



During transportation, when not in operation and during storage:

- Place in a vertical position.
- Push down the retractable wand holder on the telescopic suction wand and insert into the vacuum cleaner.

The wand holder can be moved as desired.

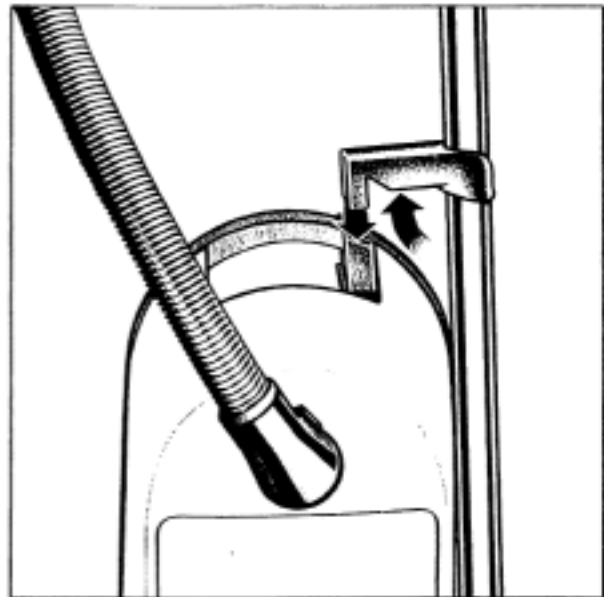

### **Park System**

A Park System has been designed for conveniently parking the vacuum cleaner during pauses. A special parking attachment is fitted to the floor nozzle and to the nose of the cleaner.

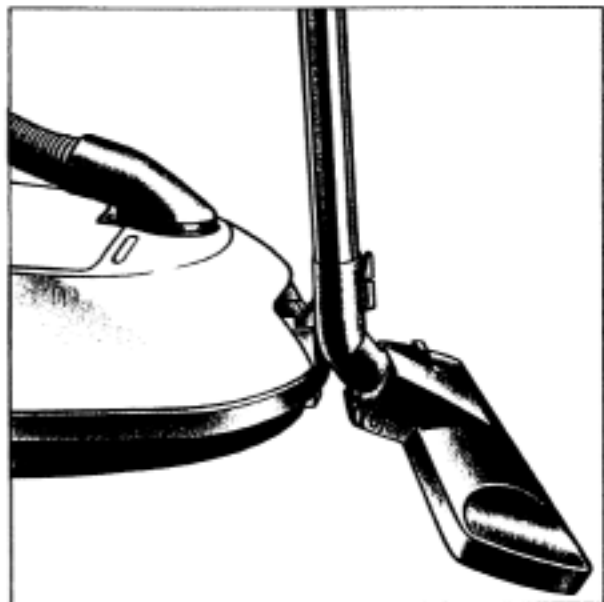

# Maintenance

---

The vacuum cleaner is fitted with three filters which must be replaced regularly in order to guarantee proper suction efficiency:

- Dustbag (paper filter bag)
- Dust compartment filter
- Exhaust filter (Miele Super Air Clean filter)

Replacement filters can be obtained from your local MIELE dealer.

**Change the dust compartment and exhaust filter each time you start a new packet of MIELE dustbags.**

**Change paper filter bag:**

when the indicator shows that the bag is full.

**Change the exhaust filter** (Super Air Clean Filter)

Each time you start a new packet of Miele paper filter bags.

**Change the dust compartment filter**

The dust compartment filter should last a long time and only needs to be changed if it gets very dirty. This may happen if, for instance, the dust bag is damaged and leaks.

**To change the filters:**

- With the machine lying flat lift the lid catch to open the dust compartment, lift lid until it clicks into place.

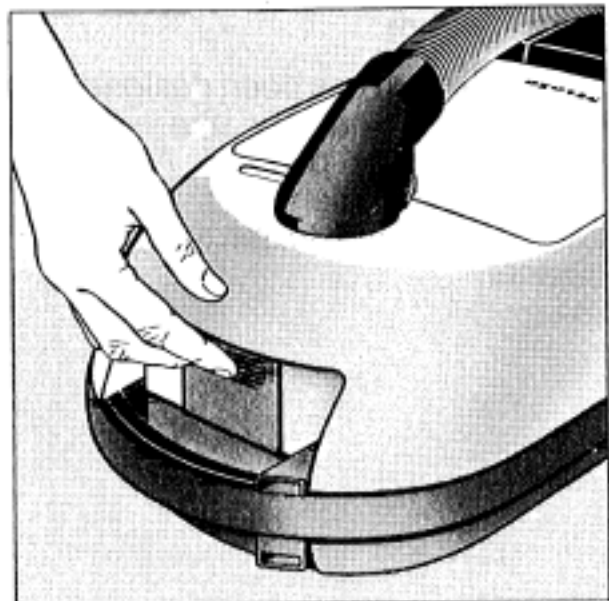

## **Paper dustbag**

The paper dustbag has a closing flap.

- To prevent dust escaping when removing the dustbag, fold the closing flap down over the bag opening.

## **Hygienic removal**

- To remove the dustbag grasp it by the card collar and pull it out. It can then be disposed of with the normal household waste.

When purchasing new dustbags, ask for Original Miele "ECO" dustbags with the card collar and closing flap.



- Place the new filter bag collar into the frame.

The cardboard dustbag collar should be clearly visible in the aperture of the frame (see arrow).

Please ensure that the dustbag is not trapped when the lid of the dust compartment is closed.

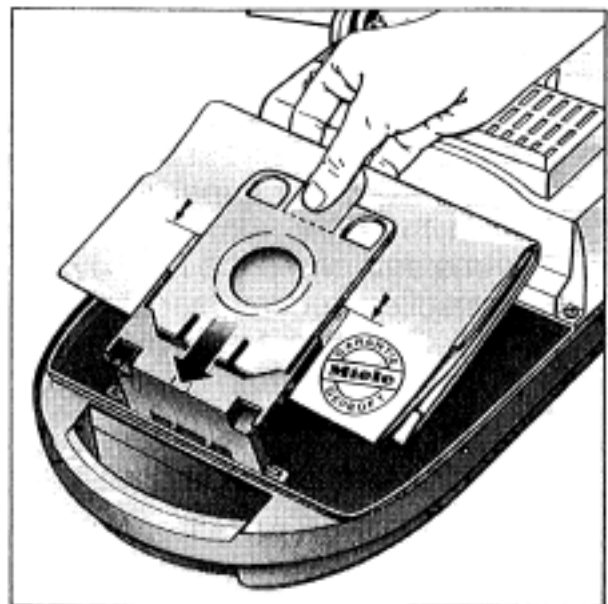

# Maintenance

---

## **Dust compartment filter**

### ● Changing the filter

The dust compartment filter should last a long time and only needs to be changed if it gets very dirty. This may happen if, for instance, the dust bag is damaged and leaks.

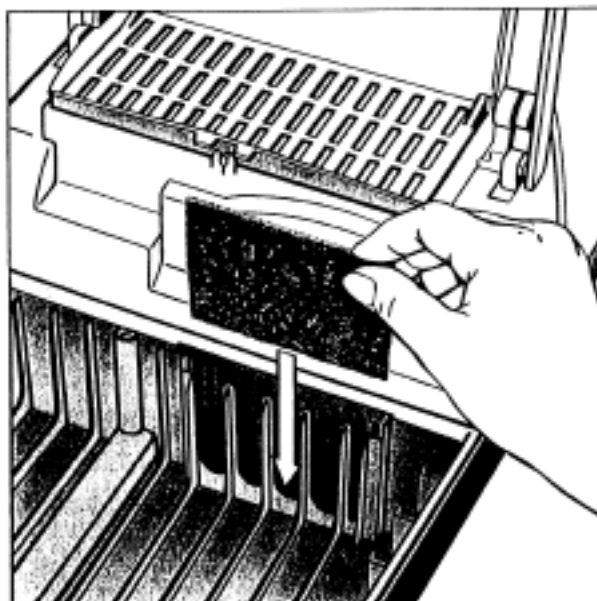

## **Exhaust filter (MIELE SUPER AIR CLEAN particle filter)**

The Miele Super Air Clean particle filter is a fine, highly efficient network of fibers, which can also catch and retain microscopically small particles of dust. The expelled air is cleaner than the original room air.

### **Change the MIELE SUPER AIR CLEAN particle filter every time you open a new pack of vacuum cleaner dustbags.**

A Super Air Clean Filter is included in every pack of Miele dustbags.

To remove the used super air clean filter from the filter frame lift up the filter frame and grasp the filter by the clean, unsoiled section (see arrow in diagram). Take it out and replace it with a new one. It can be inserted either way up.

### ● Close the filter frame firmly.

New MIELE SUPER AIR CLEAN filters can also be obtained from your Miele dealer.

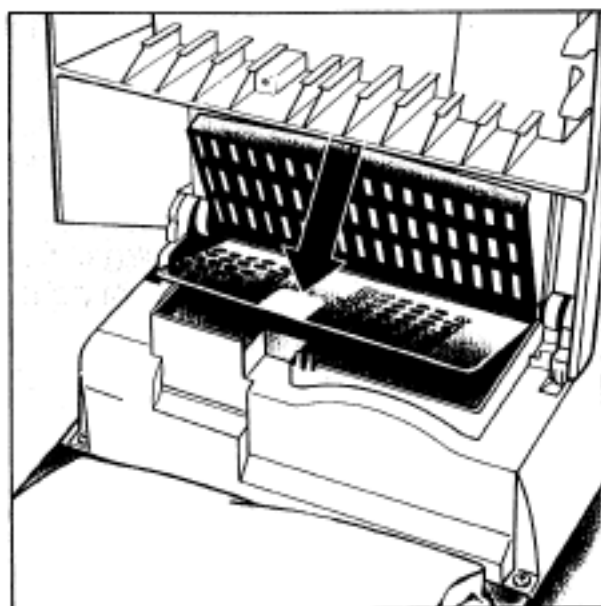

## **Changing the fiber catcher**

From time to time inspect the fiber catcher in the mouthpiece of the floor nozzle.

If the pile is worn, the fiber catcher should be replaced.

- Remove the fiber catcher from its slots, using a knife or screw-driver.
- Fit the new fiber catcher. These are available from your local dealer.

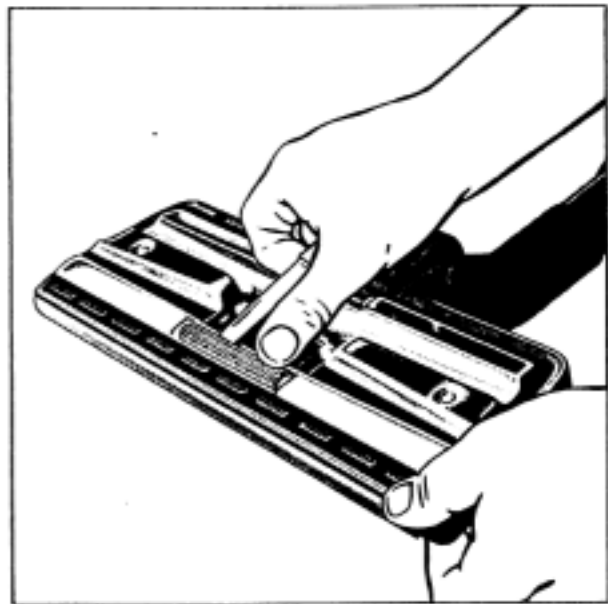

## **Cleaning and care**

The **vacuum cleaner** and all **accessories** can be cleaned with a damp cloth or with a proprietary cleaner suitable for plastic. Disconnect from the electricity supply before cleaning.

The **dust compartment** can, if necessary, be cleaned using a **dry** duster, dusting brush or, if available, by using a second vacuum cleaner to suck or blow the dust out.

## **Servicing the floor roller**

1. Lift up the axle lever
2. Slide out the axle
3. Lift out the roller

Remove foreign objects; after cleaning replace the roller assembly.

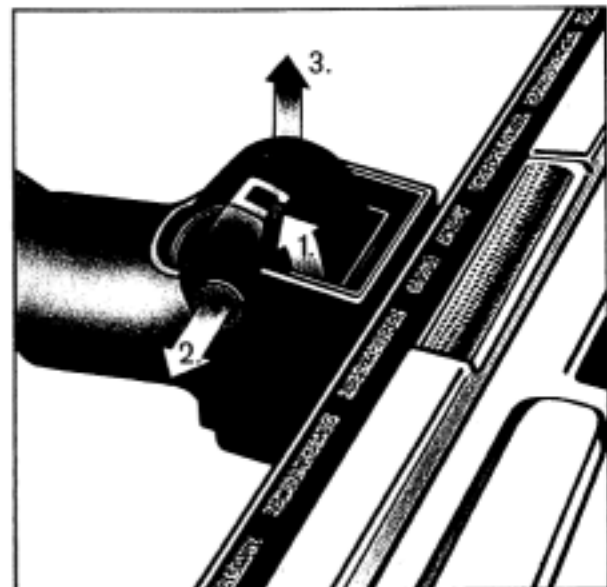

## Electrical connection

---

- Connect the vacuum cleaner only to a 120 V/60 Hz, 10 or 15 A fused receptacle.



# Miele®

---

**MIELE APPLIANCES, INC.**  
**22 D World's Fair Drive**  
**Somerset, NJ 08873**  
**Tel. No. (908) 560-0899**  
**Fax: (908) 560-9649**